

# VICTOR - 1159B

COMPACT - 1800 W MSR



- **Type:** Followspot
- **Source:** 1800 W MSR
- **PSU:** Electronic - hot restrike - DMX
- **Optics:** 7° to 14,5° zoom
- **DMX-control of motorised dimmer shutter and lamp ignition**

Followspot

## Compact but so powerful

With a combination of compact dimensions, high output to rival 2500 W followspots, hot restrike lamp, electronic PSU and DMX-control, Victor is perfect for rental companies. It has become the new benchmark followspot for large theatres, TV studios, fashion shows, concerts and touring.

### Features

- **Fully closing iris cassette:** Removable for fast, easy replacement; protective backplate for extended lifespan
- **Universal adjustable gobo holder:** A-size glass and metal gobos
- **Ergonomic dimmer control:** One-handed dim, pan and tilt
- **Smooth dimmer shutter:** Retains flat beam and colour temperature when dimming
- **Remote DMX-control:** DMX-control of motorised dimmer shutter - effects synchronising remotely with pinpoint accuracy. Control from both local and DMX through 'Master' function
- **Frost filter:** On flip lever for quick soft-edge beam effect
- **Horizontal chopper (optional):** For masking control in TV studios and wide stages
- **Internal glass filter holder:** Long term use of durable coloured, dichroic or textured glass
- **Individually removable colour frame:** Gels replaced easily while colour cassette remains in place
- **Colour changer:** 6-way, self-cancelling boomerang colour-changer
- **Scroller:** Standard scroller colour changer can be installed and powered from the unit through built-in XLR (24V+DMX) output connector
- **RJ NET:** Ensures optimum operation capacities, providing a wide pallet of feedback information (dimming level, lamp hours, projector status...) on integrated LCD display
- **DMX remote controlled ignition**
- **Easy focus reference:** Graduated scale on side of lantern; fast and easy refocusing
- **Adjustable yoke (optional):** For optimum overhead positioning
- **Fine balance:** Precision positioning and smooth operation even with the smallest movements
- **Stand:** Perfectly weighted for maximum stability with smooth rotation for optimum performance. Easy set up; triple safety system for extra security

### Optical

- **Factory set optical train:** Travels safely within followspot and requires no time-consuming realignment on arrival. Uniform beam on all followspots of same type
- **SX optical system:** Double condenser optics for exceptional optical quality
- **Gobo :** Excellent gobo projection
- **Variable zoom optics:** Sharp focus at every beam angle

### Construction

- **Made in France :** Fully manufactured on the premises retaining complete control over all aspects of quality
- **Separate PSU:** Compact for easy handling and rapid maintenance
- **Bodywork:** Strong sheet metal construction for durability
- **Ergonomic wrap-around handle:** Comfort, safety and practicality from all operating positions
- **Moving parts:** Smooth at all times, even when hot
- **Captive knobs and handles:** Additional security when working at height or in transit
- **Easy access to all parts:** Easy cleaning, re-lamping and maintenance
- **Removable assemblies:** Fast-plug cable connectors and complete component assemblies (mirror, condenser set and lamp house assembly) save maintenance and cleaning time
- **Safety:** Safety switch for secure access to the lamp

Picture:1159B

DSEN104\_1159B - 03/12/2015

Robert Juliat reserves the right to change or alter any of the items detailed on this page, to increase or improve manufacturing techniques without prior notice.

Robert Juliat S.A.S., 32 rue de Beaumont, 60530 Fresnoy-en-Thelle - France  
Telephone : +33 (0)3 44 26 51 89 - fax : +33 (0)3 44 26 90 79 - info@robertjuliat.fr  
www.robertjuliat.com



ROBERT JULIAT

## Source



- **Lamp type:** Discharge
- **Power:** 1800 W
- **Socket:** SFc 15.5-6
- **Hot re-strike:** yes

Admissible lamps	Power *	Lumen output*	Colour temperature*	Life*	CRI* (min)
MSR 1800W DE (Philips )	1 800 W	145 000 lm	6000K	750 h	>85

(\*) manufacturers data

## Optics

### Characteristics

- **Type:** Zoom
- **Beam range:** 7° to 14,5°
- **Focal length:** 283 - 589 mm

### Gel filter

- **Shape:** Circle
- **Standard size:** 210 mm (8.3 in)

### Gobo

- **Size:** A
- **Material:** Metal  
Glass

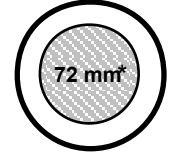

100 mm

\*Maximum image size

## Photometrics

with MSR 1800W DE (Philips ) source

### • Optics @ 7°

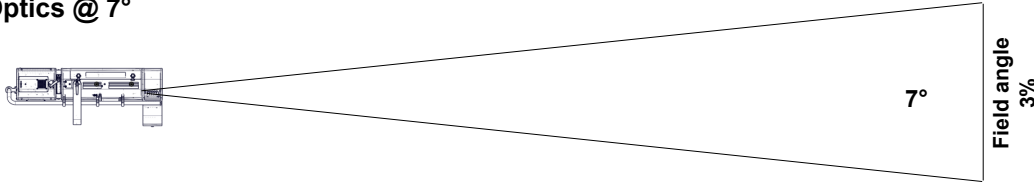

**Beam intensity**  
2 300 000 cd

<b>Distance</b>	20 m	30 m	40 m	50 m	60 m	70 m
<b>Diameter</b>	2.4 m	3.7 m	4.9 m	6.1 m	7.3 m	8.6 m
<b>Illumination</b>	5 800 lux	2 600 lux	1 450 lux	930 lux	640 lux	470 lux
<b>Distance</b>	65 ft	100 ft	130 ft	165 ft	195 ft	230 ft
<b>Diameter</b>	8 ft	12.2 ft	15.9 ft	20.2 ft	23.9 ft	28.1 ft
<b>Illumination</b>	550 fc	240 fc	140 fc	85 fc	65 fc	44 fc

### • Optics @ 14.5°

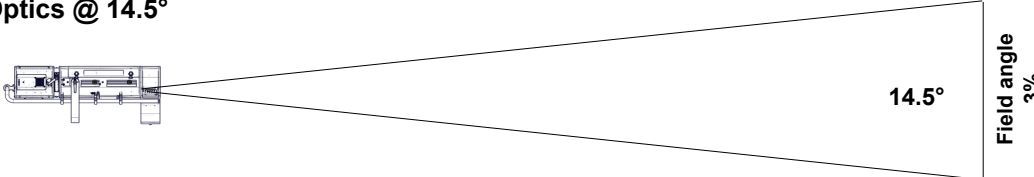

**Beam intensity**  
765 000 cd

<b>Distance</b>	20 m	30 m	40 m	50 m	60 m	70 m
<b>Diameter</b>	5.1 m	7.6 m	10.2 m	12.7 m	15.3 m	17.8 m
<b>Illumination</b>	1 950 lux	860 lux	480 lux	310 lux	220 lux	160 lux
<b>Distance</b>	65 ft	100 ft	130 ft	165 ft	195 ft	230 ft
<b>Diameter</b>	16.5 ft	25.4 ft	33.1 ft	42 ft	49.6 ft	58.5 ft
<b>Illumination</b>	190 fc	80 fc	46 fc	29 fc	21 fc	15 fc

## Remote control

• **Data protocol:** USITT DMX512-A

• **Data IN connector:** 5 pins XLR male

• **Data OUT connector** 5 pins XLR female



### • DMX chart:

#### Mode 1 (2 channels)

Mode control  
Dimmer

#### Mode 2 (3 channels)

Mode control  
Dimmer  
Dimmer fine

#### Mode 3 (3 channels)

Mode control  
Dimmer  
Dimmer master

#### Mode 4 (4 channels)

Mode control  
Dimmer  
Dimmer fine  
Dimmer master

## Dimensions and weight

### Unit

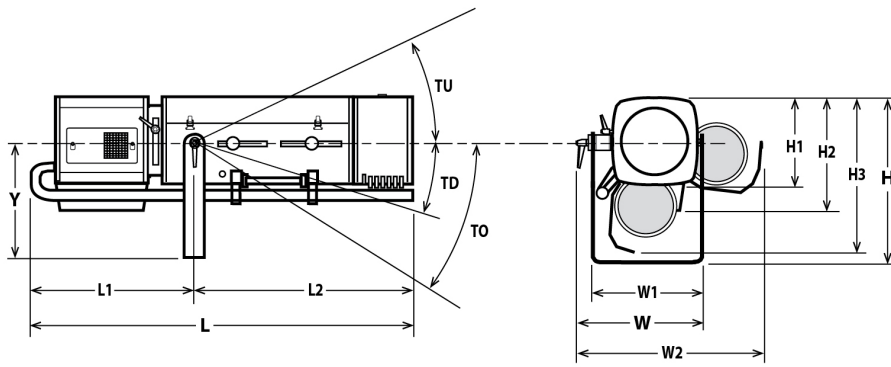

**Weight:** 36 kg (79.2 lbs)

Height	Length	Width	Yoke	Tilt	Option
H= 450 mm (17.7 in)	L= 1260 mm (49.6 in)	W= 410 mm (16.1 in)	Y= 325 mm (12.8 in)	TU= 45°	TO= TBD°
H1= 250 mm (9.8 in)	L1= 580 mm (22.8 in)	W1= 350 mm (13.8 in)		TD= 40°	
H2= 340 mm (13.4 in)	L2= 680 mm (26.8 in)	W2= 570 mm (22.4 in)			
H3= 460 mm (18.1 in)					

### Shipping

- **Weight :** 84.4 kg (185.7 lbs)
- **Volume :** .55 m<sup>3</sup> (19.42 ft<sup>3</sup>)

### PSU

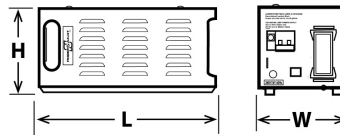

- Width:** W= 185 mm (7.3 in)
- Height:** H= 200 mm (7.9 in)
- Length:** L= 590 mm (23.2 in)
- Weight:** 13.2 Kg (29 lbs)

### Installation

- **Minimum distance to illuminated surface:** 3.5 m (11.5 ft)
- **Operating position:**

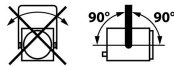

### Warranty

- **Period: 2 years**  
See General Sales Condition on website

### Approvals



### Construction

- **Housing:** Steel sheet - Aluminium
- **Colour:** Black
- **Cooling:** Low noise fan
- **Maximum ambient temperature (Ta):** 40°C (104°F)
- **Maximum case temperature (Tc) :** 230°C (446°F)
- **Total heat dissipation:** 6 963 BTU/h
- **Protection rating:** 20

- **PSU housing:** Steel sheet - Aluminium
- **PSU colour:** Black
- **PSU cooling:** Fan
- **PSU maximum ambient temperature (Ta):** 40°C (104°F)
- **PSU maximum case temperature (Tc) :** 50°C (122°F)

### Electrical compatibility

- 220/230 V - 50 Hz
- 245 V - 50 Hz
- 110/120 V - 60 Hz
- 208 V - 60 Hz
- 220 V - 60 Hz
- 100 V - 50 Hz
- 100 V - 60 Hz
- Selector: automatic detection

### Power input



- **Type:** removeable power cord with Neutrik PowerCon® (ref. NAC3FCA) connector (included)
- **Cable:** H07RNF 3G1.5
- **Length:** 3 m (9,8 ft)
- **Power connector:** CEE 7/7 (2P+E NF/Schuko)

### Power consumption

Voltage	Frequency	Current	Power	Power factor
230 V	50 Hz	8.9 A	2040 W	,98
208 V	60 Hz	?	2040 W	,97
245 V	50 Hz			TBD

### Power Supply Unit

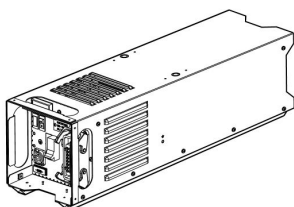





- **PSU:** Separate - Electronic PSU - Flicker free with PFC
- **Lighting unit / PSU cable:** Removable cable - length: 3 m (9,8 ft)  
Type: 18G1,5 JZ 602-RC (CE-UL/CSA) with 16x16A+E Harting Han® connectors
- **Maximum distance between lighting unit and PSU:** 25 m (82 ft)
- **Control:** Local / DMX
- **Protection:** Mains: 16A 2P2D - C curve breaker / Electronic: 2A 5x20 time-delay fuse









## Model

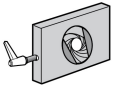











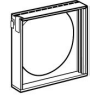

<b>1159B</b>	1800 W MSR Followspot - 1159B Victor - 7/14,5° - Electronic PSU - DMX dimmer and lamp control
--------------	---

## Options

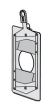
<b>PCP1716A</b>	16A blue 2P+E 6h IEC60309 power connector	
<b>FRO/1117PV</b>	Heavy duty adjustable yoke	
<b>PG80</b>	Ø80mm chopper kit (G80+ GR120+ adaptation kit)	
<b>M210TM</b>	6 ways "push/pull" colour changer	
<b>CAG/C</b>	Left side controls (Iris/Dimmer/Frost/Colour changer)	
<b>FC1459</b>	Flight-case for Compact range + GT stand + P.S.U. + accessories - Dim: 1340x710x700mm - Poids: 55 Kg	

## Accessories

<b>MSR 1800W DE</b>	MSR 1800W DE - Philips SFc 15.5-6 1800W V 750h 6000K lamp <b>1 included</b>	
<b>CCU1</b>	Full closing iris cassette - Weight: 1,33 Kg <b>1 included</b>	
<b>PF1011</b>	Ø210 mm metal filter holder <b>6 included</b>	
<b>SGUP</b>	Universal "A" size gobo-holder (metal, glass, frosted glass) <b>1 included</b>	
<b>FACM100</b>	Ø97mm UV/IR filter with holder <b>1 included</b>	
<b>VDM100</b>	Ø97mm frosted glass with holder <b>1 included</b>	
<b>M210B</b>	6 ways "boomerang" colour changer - Weight: 3,36 Kg <b>1 included</b>	
<b>TC1149</b>	Tool case with spare parts - Weight: 1,65 Kg <b>1 included</b>	
<b>GT1000</b>	Tripod stand - SWL: 40 Kg - max. height: 1550 mm - Weight: 9,27 Kg	
<b>GT4000</b>	Tripod stand with safety chain - SWL: 130 Kg - max. height: 1030 mm - Weight: 7,91 Kg	

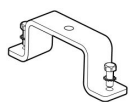
<b>GT400S</b>	Tripod stand without safety chain - SWL: 130 Kg - max. height: 1030 mm - Weight: 8,65 Kg	
<b>JPP</b>	Monopod stand for overhead followspot - Weight: 3,6 Kg	
<b>T1000</b>	TV spigot with followspots swivel head - Weight: 1,82 Kg	
<b>T4000</b>	Followspot mount for Ø50mm pipe (suspension or overhead) - SWL= 100 Kg - Weight: 4,88 Kg	
<b>CAV700A</b>	Double slot front cassette for 215x215mm accessories - Weight: ,52 Kg	
<b>FCM100</b>	Ø97mm CTO correction filter (5500K → 3400K) with holder	
<b>VD120</b>	120x120mm frosted glass	
<b>FRO/1017PD</b>	Heavy duty adjustable yoke - Weight: 4,33 Kg	
<b>Kit G80</b>	Ø80mm chopper kit (G80+ GR120+ adaptation kit) - Weight: ,69 Kg	
<b>M210T</b>	6 ways "push/pull" colour changer - Weight: 3,67 Kg	
<b>M210TVCL</b>	Light shield for M210T push/pull colour changer - Weight: 1,98 Kg	
<b>Kit TELRAD</b>	Telrad followspot sight with raiser and universal mounting kit - Weight: 1,23 Kg	
<b>P1FCAN</b>	Remote controller for dimming shutters - Weight: ,44 Kg	
<b>FC1459/S</b>	Flight-case for Compact range + GT stand + P.S.U. + accessories - Weight: 55 Kg	
<b>OmegaP</b>	Omega bracket with screw for PSU	
<b>W/GT800</b>	Set of 3 wheels for GT800/1000 stand - Weight: 2,33 Kg	