

Super LED F4.7

60 W High Power – Enhanced CRI

LED Fresnel SPOTLIGHT CRI greater than 90

White light, either Tungsten or Daylight balanced Correlated Colour Temperature



Led Leonardo Standard Range



Super Led Fresnel Range



LED Lighting, Green Energy

OVERVIEW

The Super LED F4.7 is a high efficiency Fresnel lens spotlight using the innovative High Power 60W COB (Chip on Board) LED ARRAY, in combination with the DE SISTI Internationally Patented optical system for LED FRESNEL and with an enhanced CRI (Color Rendering Index) higher than 90 for appropriate chromacity performances.

The Lighting Fixture is DMX Controlled from 0 to 100% with a super smooth Dimming and a negligible variation of Colour Temperature while controlling the Light intensity.

The LED MAGIS is available with either Tungsten (3.200°K) or Daylight (5.600°K) Balanced CCT (Correlated Color Temperature), in both cases with a CRI higher than 90 and both in Manual or Pole operated versions.

The lighting Performances of the Tungsten Balanced CCT from medium to full flood are similar to those of a 750W tungsten Fresnels, while the Daylight Balanced CCT is similar to a 250W HMI.

The fixture combines the classical SPOT/FLOOD beam control on an equivalent FOCUS RANGE to a conventional lamp fresnel, with an excellent barn door cutting.

It utilizes Standard accessories from the DE SISTI range of equivalent Fresnel Lens size, such as Barndoor, Colour Frame, Cones, scrims.

FEATURES

- 120 mm. (4.75") diameter high quality, shock resistant Borosilicate glass Fresnel lens on spring supports.
- Rugged and Lightweight Carbon Steel housing with low glare black epoxy powder coating, with internal double walls and reinforces.
- High efficiency Self Stabilizing Active Cooling: Automatic, thermal stabilization of the LED operating temperature is managed by an internal thermal sensor and CPU, variable speed fan and heat sink to maintain the LED Array's constant temperature at a maximum of 65°C. The hydro dynamic bearing fan operates silently with a very low RPM.
- Special Patented Optics for LED Technology.
- Helix Screw driven focus mechanism which guides Teflon bushings supported LED ENGINE along 2 rods. This ensures smooth operation during focusing, in any tilting position of the fixture. The Teflon bushings also provide a wiping action, which cleans the steel guide rails during focus
- The unit is equipped with a hinged lens door with wire-guard, it includes accessory holding brackets. One of the 4 brackets has a locking knob and is spring loaded, it can be locked to either safely hold barndoor, color frame and scrims or to be rotated 90° and locked in an open position for fast accessories changes.
- The accessories are secure regardless of the orientation of the fixture. Accessories have been designed for one hand installation.
- Available with either positive lock manual yokes for comfort and ease of handling, or pole operated yokes which can be used via the lighting pole for Panning and Tilting the lights as well as manually, since the mechanical activators are equipped with clutches.

CHARACTERISTICS & PERFORMANCE DATA

DESCRIPTION	VALUE	
➔ Power to LED	60W DC Current to the LED (no flicker)	
➔ Power Consumption	Europe	America
	71W @ 230 V 50-60 Hz	75W @ 120 V 50-60 Hz
➔ DMX Data link USITT DMX512-A	This product uses a 5-pin XLR for DMX input and output. Use a shielded data cables. Do not overload the daisy chain. Up to a maximum of 32 devices can be used on a single DMX chain.	
➔ DMX Channels	1 at 8bit: Dimmer 2 at 16bit: Dimmer	
➔ LED ARRAY Lifetime	50.000 hours with 70% Lumen Maintenance. The LED ARRAYS are tested and certified up to LM80	
➔ Protection Type	IP 22	
➔ Max. Housing Surface Temperature	70° C	
➔ Weight of Fixture	M.O.	P.O.
	3,5 kg.	5,4 kg.
➔ Weight of Barndoor	4 leaf	8 leaf
	0,3 kg.	0,4 kg.
➔ Size of Barndoor ring	Diameter	
	133 mm	
➔ Weight of color frame	0,13 kg.	
➔ Size of scrims & color frame	Diameter	
	129 mm	
➔ Lens diameter	120 mm. 4.75"	

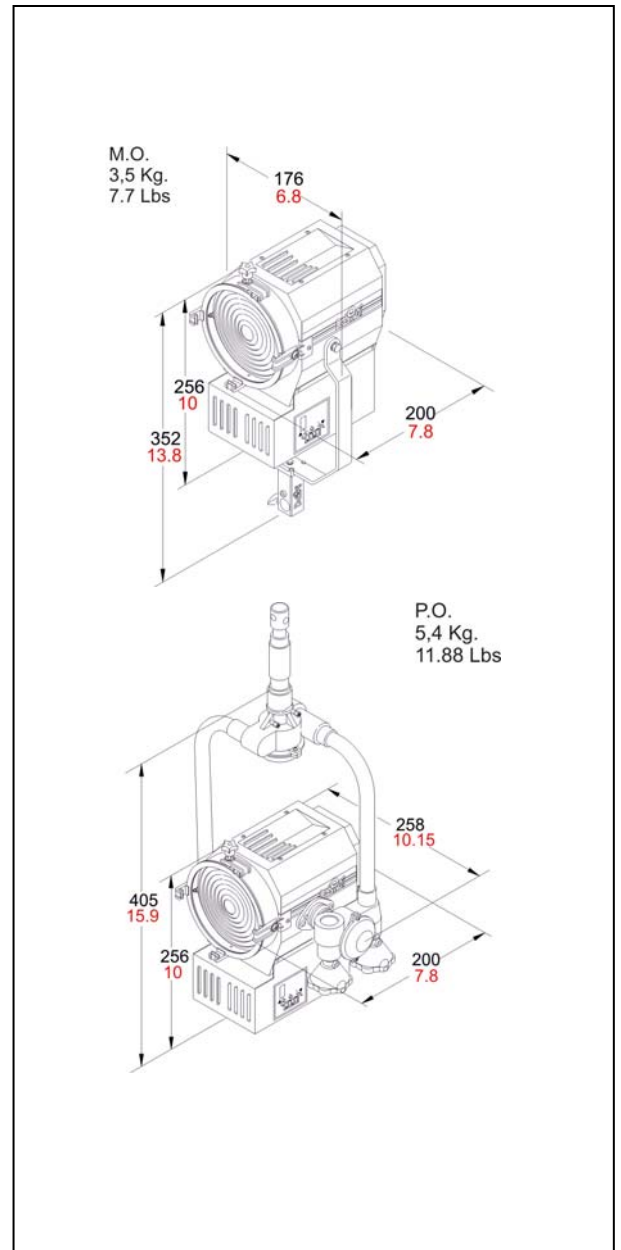

POWER AND DMX DAISY CHAIN



The Super LED FRESNELS permit both POWER and DMX DAISY CHAIN. In fact each Fixture is respectively equipped with:

- For DMX:
 - 1 XLR5 pin Panel Mount Male & Female (DMX IN & OUT)
- For Mains Supply
 - 1 20A Powercon NAC3MPA BLUE (POWER IN)
 - 1 20A Powercon NAC3MPB WHITE (POWER OUT)

PHOTOMETRIC DATA

C.C.T. (Correlated Color Temperature) balanced to match 3.200°K TUNGSTEN LAMPS

PHOTOMETRIC DATA SUPER LED F4.7T - 60W (CRI 92)

C.C.T. (Correlated Color Temperature) balanced to match 3.200°K TUNGSTEN LAMPS

Illumination center values at Distances	885 lux	319 lux	80 lux	
Central Light intensity (Candle Power)	7.965 cd	82 FC	30 FC	
Light beam diameter with Beam Angle	2,24 mt	3,74 mt	7,48 mt	
(50% of center value):	41,0°	7,4 ft	12,3 ft	
Light beam diameter with Field Angle	3,75 mt	6,25 mt	12,50 mt	
(10% of center value):	64,0°	12,3 ft	20,5 ft	
FULL FLOOD	DISTANCES	3 mt	5 mt	10 mt
		9,8 ft	16,4 ft	32,8 ft

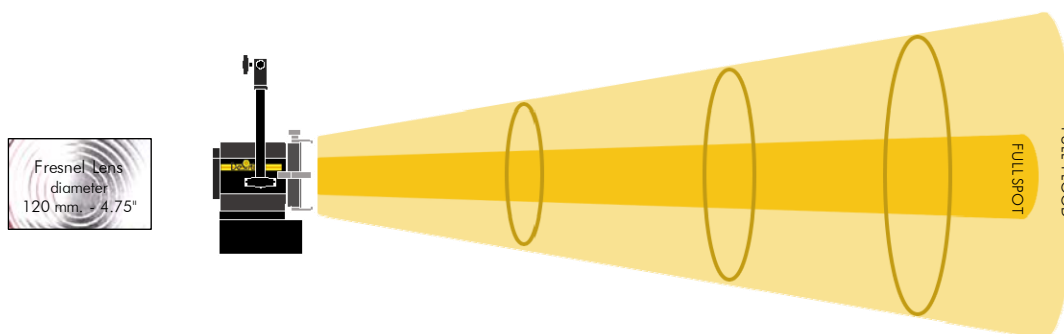

FULL SPOT	DISTANCES	3 mt	5 mt	10 mt
		9,8 ft	16,4 ft	32,8 ft
Illumination center values at Distances	3.580 lux	1.289 lux	322 lux	
Central Light intensity (Candle Power)	32.220 cd	333 FC	120 FC	
Light beam diameter with Beam Angle	0,63 mt	1,05 mt	2,10 mt	
(50% of center value):	12,0°	2,1 ft	3,4 ft	
Light beam diameter with Field Angle	1,17 mt	1,94 mt	3,89 mt	
(10% of center value):	22,0°	3,8 ft	6,4 ft	

LUX AT ANY DISTANCE = Candle Power : [Distance(in m.)]²

F.C. AT ANY DISTANCE = Candle Power : [Distance(in ft)]²

De Sisti Super LED F4.7T – 60W : CCT = P3005 (+0.3)

TLCI-2012 : 91 (P3005)

Television Lighting Consistency Index-2012

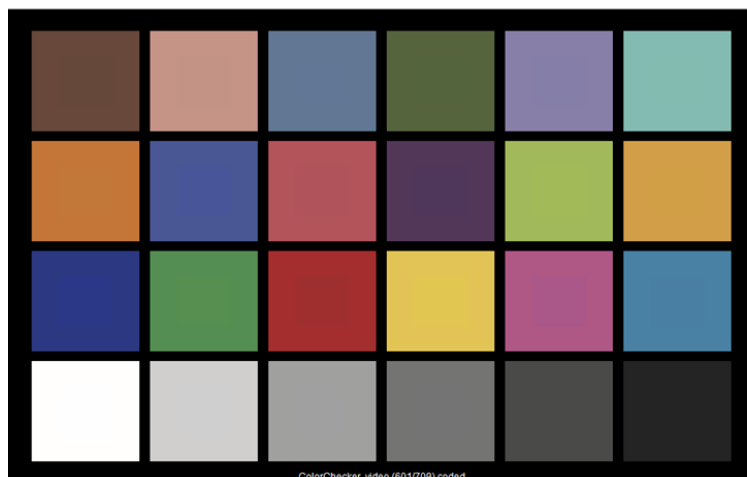

Sector	Lightness	Chroma	Hue
R	0	0	0
R/Y	0	0	--
Y	0	-	-
Y/G	0	-	0
G	0	0	+
G/C	0	0	+
C	0	0	++
C/B	+	0	-
B	0	-	-
B/M	+	-	+
M	0	0	+++
M/R	+	0	++

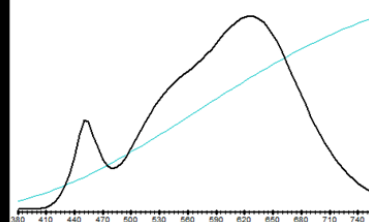

PHOTOMETRIC DATA

C.C.T. (Correlated Color Temperature) balanced to match 5.600°K DAYLIGHT LAMPS

PHOTOMETRIC DATA SUPER LED F4.7D - 60W (CRI 95)

C.C.T. (Correlated Color Temperature) balanced to match 5.600°K DAYLIGHT LAMPS

Illumination center values at Distances	890 lux	320 lux	80 lux	
Central Light intensity (Candle Power) 8.010 cd	83 FC	30 FC	7 FC	
Light beam diameter with Beam Angle	2,24 mt	3,74 mt	7,48 mt	
(50% of center value): 41,0°	7,4 ft	12,3 ft	24,5 ft	
Light beam diameter with Field Angle	3,75 mt	6,25 mt	12,50 mt	
(10% of center value): 64,0°	12,3 ft	20,5 ft	41,0 ft	
FULL FLOOD	DISTANCES	3 mt	5 mt	10 mt
		9,8 ft	16,4 ft	32,8 ft

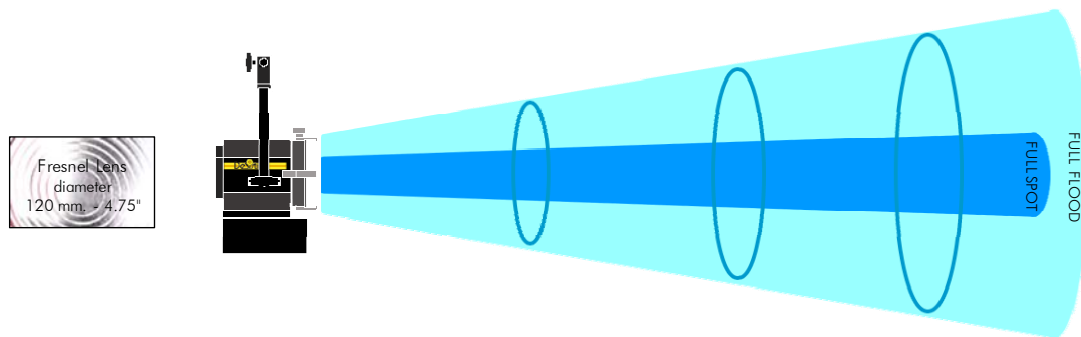

FULL SPOT	DISTANCES	3 mt	5 mt	10 mt
		9,8 ft	16,4 ft	32,8 ft
Illumination center values at Distances	3.700 lux	1.332 lux	333 lux	
Central Light intensity (Candle Power) 33.300 cd	344 FC	124 FC	31 FC	
Light beam diameter with Beam Angle	0,63 mt	1,05 mt	2,10 mt	
(50% of center value): 12,0°	2,07 ft	3,45 ft	6,90 ft	
Light beam diameter with Field Angle	1,17 mt	1,94 mt	3,89 mt	
(10% of center value): 22,0°	3,83 ft	6,38 ft	12,75 ft	

LUX AT ANY DISTANCE = Candle Power : [Distance(in m.)]²

F.C. AT ANY DISTANCE = Candle Power : [Distance(in ft)]²

De Sisti Super LED F4.7D – 60W : CCT = D5851 (+0.8)
TLCI-2012 : 93 (D5851)

Television Lighting Consistency Index-2012



Sector	Lightness	Chroma	Hue
R	0	0	0
R/Y	-	0	--
Y	0	0	-
Y/G	0	0	0
G	0	0	0
G/C	0	0	0
C	0	0	-
C/B	+	0	---
B	0	-	0
B/M	0	0	+
M	0	0	0
M/R	+	0	0

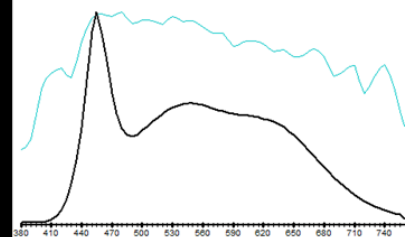

Super LED F4.7 VERSIONS & MODEL NUMBERS

MOD.	DESCRIPTION
TUNGSTEN BALANCED CCT (CRI higher than 90)	
"F4.7T".MO	<p>Super LED "F 4.7 T" - high power CRI>90 Tungsten CCT, M.O. LED Fresnel Spotlight including:</p> <ul style="list-style-type: none"> - Mod. "F4.7T".MO.H M.O. FIXTURE HEAD with - 120 mm. (4.75") diameter Fresnel lens - POWERCON IN & OUT PANEL MOUNTED CONNECTORS. - XLR 5 Pin DMX IN & OUT PANEL MOUNTED CONNECTORS. - 60W high power CRI>90 LED with Tungsten Balanced Correlated Color Temperature (CCT) - Built In Universal Power Supply 120-230-240V 50/60Hz DMX controlled. - Mod. 5403.135 3 mt. detachable Blue POWERCON power cable with bare ends - Mod. LT300.100.40 M.O. stirrup with 16 mm. Socket - Mod. 306.100 four leaf rotating barndoor - Mod. 307.100 colour frame <p>DMX cable is not included, to be ordered separately</p>
"F4.7T".PO	<p>Super LED "F 4.7 T" - high power CRI>90 Tungsten CCT, P.O. Pan & Tilt (Manual focus) LED Fresnel Spotlight including:</p> <ul style="list-style-type: none"> - Mod. "F4.7T".MO.H M.O. FIXTURE HEAD with - 120 mm. (4.75") diameter Fresnel lens - POWERCON IN & OUT PANEL MOUNTED CONNECTORS. - XLR 5 Pin DMX IN & OUT PANEL MOUNTED CONNECTORS. - 60W high power CRI>90 LED with Tungsten Balanced Correlated Color Temperature (CCT) - Built In Universal Power Supply 120-230-240V 50/60Hz DMX controlled. - Mod. 5403.135 3 mt. detachable Blue POWERCON power cable with bare ends - Mod. 301.110.40 P.O. yoke with 28,57 mm. spigot (B.S. 1 1/8"), with top end for "C" clamp - Mod. 306.100 four leaf rotating barndoor - Mod. 307.100 colour frame <p>DMX cable is not included, to be ordered separately</p>
The Model Number for the DIN Spigot Version is "F4.7T".PO.DIN	
DAYLIGHT BALANCED CCT (CRI higher than 90)	
"F4.7D".MO	<p>Super LED "F 4.7 D" - high power CRI>90 Daylight CCT, M.O. LED Fresnel Spotlight including:</p> <ul style="list-style-type: none"> - Mod. "F4.7D".MO.H M.O. FIXTURE HEAD with - 120 mm. (4.75") diameter Fresnel lens - POWERCON IN & OUT PANEL MOUNTED CONNECTORS. - XLR 5 Pin DMX IN & OUT PANEL MOUNTED CONNECTORS. - 60W high power CRI>90 LED with Daylight Balanced Correlated Color Temperature (CCT) - Built In Universal Power Supply 120-230-240V 50/60Hz DMX controlled. - Mod. 5403.135 3 mt. detachable Blue POWERCON power cable with bare ends - Mod. LT300.100.40 M.O. stirrup with 16 mm. Socket - Mod. 306.100 four leaf rotating barndoor - Mod. 307.100 colour frame <p>DMX cable is not included, to be ordered separately</p>
"F4.7D".PO	<p>Super LED "F 4.7 D" - high power CRI>90 Daylight CCT, P.O. Pan & Tilt (Manual focus) LED Fresnel Spotlight including:</p> <ul style="list-style-type: none"> - Mod. "F4.7D".MO.H M.O. FIXTURE HEAD with - 120 mm. (4.75") diameter Fresnel lens - POWERCON IN & OUT PANEL MOUNTED CONNECTORS. - XLR 5 Pin DMX IN & OUT PANEL MOUNTED CONNECTORS. - 60W high power CRI>90 LED with Daylight Balanced Correlated Color Temperature (CCT) - Built In Universal Power Supply 120-230-240V 50/60Hz DMX controlled. - Mod. 5403.135 3 mt. detachable Blue POWERCON power cable with bare ends - Mod. 301.110.40 P.O. yoke with 28,57 mm. spigot (B.S. 1 1/8"), with top end for "C" clamp - Mod. 306.100 four leaf rotating barndoor - Mod. 307.100 colour frame <p>DMX cable is not included, to be ordered separately</p>
The Model Number for the DIN Spigot Version is "F4.7D".PO.DIN	
5402.503	<p>DMX DAISY CHAIN CABLE 3 mt. (10') LONG, including: - 3 mt. (10') cable terminated with XLR 5 pin Connectors (male and female) at the ends, to allow daisy chain of DMX fixtures.</p>

Super LED F4.7 *OPTIONALS & ACCESSORIES*

MOD.	Super LED F4.7 High power - Enhanced CRI - <i>OPTIONALS & ACCESSORIES</i>
305.310	Stainless Steel wire guard
306.100	Four leaf rotating barndoor
306.200	Eight way rotating barndoor
307.100	Colour Frame
308.100	Cone with two discs (with front aperture diameter: 70 mm. 50 mm. 30 mm.)
309.100	Set of scrims - Stainless steel
309.101	Full single scrim - Stainless steel
309.102	Full double scrim - Stainless steel
309.103	1/2 single scrim - Stainless steel
309.104	1/2 double scrim - Stainless steel
91.210	Aluminum black painted "C" clamp to hang fixtures overhead and for mounting on pipe with diameters up to 52 mm. (2"), with safety pin (no adapters)
93.101	Extruded black "C" clamp with 16mm. (5/8") stud
93.104	Extruded black "C" clamp with M 8 threaded stud
20.100	Safety cable 800 mm. long with 4 mm. diameter steel rope and safety catch.
302.631	KIT CASE in REINFORCED MOLDED POLYETILEN for 3 LIGHTS AND ACCESSORIES, including: - Black Colour - 3 Sides Carrying Handles - Alluminium profiles, Heavy duty cam-lock, hinges and rolling wheels - for: Magis kit 300.600 - DLK 380 - DLK3100.



INCREASED OUTPUT Super LED F4.7 versus LED MAGIS 4.7:

The SUPER LED F4.7 is featuring an important increase of Light output if compared to the standard LED MAGIS.

The table shows the Main Lighting Parameters comparison between the Super LED F4.7 and the LED MAGIS.

	Standard Version	Super LED	Standard Version	Super LED
	LED MAGIS Tungsten CCT 55W	Super LED F 4.7 T Tungsten CCT 60W	LED MAGIS Daylight CCT 55W	Super LED F 4.7 D Daylight CCT 60W
Measuring distance	3 mt	3 mt	3 mt	3 mt
		Central Light Intensity Increase		Central Light Intensity Increase
FULL FLOOD		26,61%		17,72%
Illumination center values at Distances	699 lux	885 lux	756 lux	890 lux
Central Light intensity (Candle Power)	6.291 cd	7.965 cd	6.804 cd	8.010 cd
FULL SPOT		19,33%		12,77%
Illumination center values at Distances	3.000 lux	3.580 lux	3.281 lux	3.700 lux
Central Light intensity (Candle Power)	27.000 cd	32.220 cd	29.529 cd	33.300 cd

ENERGY SAVINGS:

The Energy Savings introduced by this products are remarkable. The following table shows a Comparison of the energy conversion for both Tungsten and Daylight Super LED F4.7 when compared respectively to a 750 W Tungsten Fresnel and outperforms a 250W HMI, which are the equivalent lighting performance conventional fixtures, when analysing the output beam from middle to full flood:

DE SISTI - SUPER LED F4.7 Energy & Thermal Savings versus equivalent Conventional Fixtures

The DE SISTI LED FRESNELS Tungsten are:

- 100% Dimmable locally or via DMX with super smooth dimming dynamics
- No separate DIMMERS required (No Dimmer Room and Simpler Cabling system)
- All self contained in the Luminaire housing (no separate ballasts or power supply)
- Power and DMX Days chain able
- High energy savings when compared to Tungsten Fixtures with negligible POWER REQUIREMENTS and very low Thermal Emission for contained cooling systems in the studio.
- Extremely contained Maintenance (mostly cleaning): no lamps replacement

ENERGY CONVERSION	
Visible Light	8%
IR	73%
UV	0%
Total Radiant Energy	81%
Heat (Conduction + Convection)	19%
Total Power Consumption of Lighting Fixture	100%
Total % of Input Energy converted in Thermal Dissipation	92%

ENERGY SAVINGS on LIGHTING FIXTURE consumption with DE SISTI LED
THERMAL EMISSION SAVINGS with DE SISTI LED

BTU to refrigerate the Dissipation of the Lighting Fixture	2.355 BTU
HVAC Power Consumption to produce the above BTU	220 W

Tot. CONSUMPTION in kWhrs in 2600 hrs (typical yearly use)
TOTAL yearly cost for Electricity per Fixture with 1 kWh = 0,2 €

TOTAL ENERGY SAVINGS with DS LEDS
= on LIGHTING FIXTURE + HVAC consumption

SUPER LED F4.7T 60W Tungsten balanced CCT Energy & Thermal Savings versus equivalent Filament Fixture			
The lighting Performances of the 60W Tungsten Balanced CCT are comparable from medium to full flood to those of a 750W tungsten Fresnels			
Tungsten Fresnel	750 W	LED Fresnel	60 W
Visible Light	8%	25%	15 W
IR	73%	0%	0 W
UV	0%	0%	0 W
Total Radiant Energy	81%	0%	0 W
Heat (Conduction + Convection)	19%	75%	45 W
Total Power Consumption of Lighting Fixture	100%	100%	60 W
Total % of Input Energy converted in Thermal Dissipation	92%	75%	45 W
ENERGY SAVINGS on LIGHTING FIXTURE consumption with DE SISTI LED		92%	
THERMAL EMISSION SAVINGS with DE SISTI LED		93%	
BTU to refrigerate the Dissipation of the Lighting Fixture		2.355 BTU	154 BTU
HVAC Power Consumption to produce the above BTU		220 W	14 W
Tot. CONSUMPTION in kWhrs in 2600 hrs (typical yearly use)		2.521 kWh	193 kWh
TOTAL yearly cost for Electricity per Fixture with 1 kWh = 0,2 €		€ 504,29	€ 38,65
TOTAL ENERGY SAVINGS with DS LEDS = on LIGHTING FIXTURE + HVAC consumption		Per Fixture Savings € 465,6	Per Fixture Savings in % 92%

The DE SISTI LED FRESNELS Daylight are:

- much less expensive then equivalent HMIs fixtures
- They are 100% Dimmable locally or via DMX with super smooth dimming dynamics
- All self contained in the Luminaire housing (no separate ballasts or power supply)
- Power and DMX Days chain able
- Yet introduce significant energy savings when compared to HMIs
- Extremely contained Maintenance (mostly cleaning): no expensive lamps replacement

ENERGY CONVERSION	
Visible Light	27%
IR	17%
UV	19%
Total Radiant Energy	63%
Heat (Conduction + Convection)	37%
Total Power Consumption of Lighting Fixture	100%
Total % of Input Energy converted in Thermal Dissipation	73%

ENERGY SAVINGS on LIGHTING FIXTURE consumption with DE SISTI LED
THERMAL EMISSION SAVINGS with DE SISTI LED

BTU to refrigerate the Dissipation of the Lighting Fixture	623 BTU
HVAC Power Consumption to produce the above BTU	58 W

Tot. CONSUMPTION in kWhrs in 2600 hrs (typical yearly use)
TOTAL yearly cost for Electricity per Fixture with 1 kWh = 0,2 €

TOTAL ENERGY SAVINGS with DS LEDS
= on LIGHTING FIXTURE + HVAC consumption

SUPER LED F4.7D 60W Daylight balanced CCT Energy & Thermal Savings versus equivalent Daylight Discharge Lamp Fixture			
The lighting Performances of the 60W Daylight Balanced CCT are comparable from medium to full flood to those of a 250W HMI Fresnel.			
HMI Fresnel	250 W	LED Fresnel	60 W
Visible Light	27%	25%	15 W
IR	17%	0%	0 W
UV	19%	0%	0 W
Total Radiant Energy	63%	0%	0 W
Heat (Conduction + Convection)	37%	75%	45 W
Total Power Consumption of Lighting Fixture	100%	100%	60 W
Total % of Input Energy converted in Thermal Dissipation	73%	75%	45 W
ENERGY SAVINGS on LIGHTING FIXTURE consumption with DE SISTI LED		76%	
THERMAL EMISSION SAVINGS with DE SISTI LED		75%	
BTU to refrigerate the Dissipation of the Lighting Fixture		623 BTU	154 BTU
HVAC Power Consumption to produce the above BTU		58 W	14 W
Tot. CONSUMPTION in kWhrs in 2600 hrs (typical yearly use)		801 kWh	193 kWh
TOTAL yearly cost for Electricity per Fixture with 1 kWh = 0,2 €		€ 160,23	€ 38,65
TOTAL ENERGY SAVINGS with DS LEDS = on LIGHTING FIXTURE + HVAC consumption		Per Fixture Savings € 121,6	Per Fixture Savings in % 76%

DE SISTI LED FRESNELS – LIGHTING QUALITY FIRST:

When choosing a FRESNEL you are expecting:

- Appropriate and effective Focusing Range from Spot to Flood
- Single shadows and their consistency within the Flood Field
- Even and wide Flood with appropriate Barn-door capability

This is exactly what you get with the DE SISTI LED FRESNELS.

The Internationally Patented Optical system specifically developed by DE SISTI to optimize the use of a LED Engine Technology in combination with a Fresnel Lens (or a Plano Convex) is providing to the DE SISTI LED FRESNELS the exact same lighting projection you would expect from a Standard Fresnel.

The following EXAMPLE SHOWS a COMPARISON between:

LED FIXTURE by "OTHERS" NOT REAL FRESNEL performances



- The Beam in full flood is NARROW (only 45°) and shows an HOT SPOT (large area to go from Beam to Field Angle)



- The Barndoor in a NOT REAL FRESNEL optics does not work properly: the projection is OVAL and the more you barndoor the more you dim the central beam



LED FIXTURE by "DE SISTI" EXACT FRESNEL performances



- The Beam in full flood is LARGE (above 50°), even and flat (No Hot Spots and rapid passage from Beam to Field Angle)

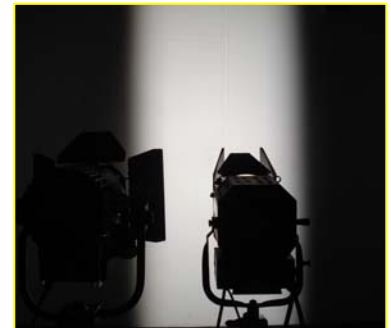

- The Barndoor on the DE SISTI LED FRESNEL has exactly the same functionality obtained with a PROPER FRESNEL optics.