

eco Stage

C-225 Moving Led Spot



eco
stage

DANOR
DANOR Theatre & Studio Systems, 9 Hanagar st. Hod Hasharon, Israel

USER MANUAL

TABLE OF CONTENTS

Maintenance-----	1
Statement-----	1
Attention Item -----	2
Product introduction -----	2
16Control Channel -----	3
11Control Channel -----	7
That Control Display-----	10
Fault conditions-----	14

Maintenance

1. Please keep the light in dryness and avoiding use in wet place.
2. Using intermittently can be extended the life.
3. Attention to clean the fan and lens usually in order to get the ventilating effects and lighting effects better.
4. Please do not wipe the crust using organic menstruum for avoid to damage the product.

Statement

The product has well capability and intact packing when leave factory. All of the user should comply with above warning item and manual, any misuse cause of the damages are not included in our guarantee, and also can not be responsible for any malfunction & problem owing to ignore the manual.

Please forgive that we will not be notice for technical change.

Attention Item

1. For guarantee the life of product, please don't put it on the wet place and also not use it in the place over 40 degree.
2. Please don't lay the product on the unfixable or shakable place.
3. Ask for the professional to maintain the product in order to avoid the danger of get an electric shock.
4. Power supply should not be changed over $\pm 10\%$ while the light is using, it will be decreased the life of lamp if the power is too high, but it will be influenced the luminosity if the power is too low.
5. After power off, if it is need used again, please cool down over 20 minutes.
6. Please look round the manual for ensure the product can be used normally.

Product introduction

Power supply: AC100-240V, 60/50Hz

Power consumption: 380W

Fiting lamp: 225W

DMX-control-channels: 16 or 11

Colour-wheel 1: 7 single filter + White + Rainbow-effect

Gobo-wheel 1: 8 staic gobo (with gobo shake) + open + Rainbow-effect

Gobo-wheel 2: 7 rotating gobo + open + Rainbow-effect

Shuttle: Flash rate: 0-20Hz

Effect wheel: 3-face prism (controllable rotating speed, adjustable positive & negative)

Focus: motorized focus

Dimmer: 0~100% mechanic dimmer

Iris: 0~100% mechanic adjustable

Maximum PAN-movement: 540° , self-correcting

Maximum TILT-movement: 270° , self-correcting

8bit / 16bit PAN/TILT movement resolution

Master/Slave ativated by sound at pre-programmed function.

16 Control Channel

Accept DMX512 control channel, detail as follow:

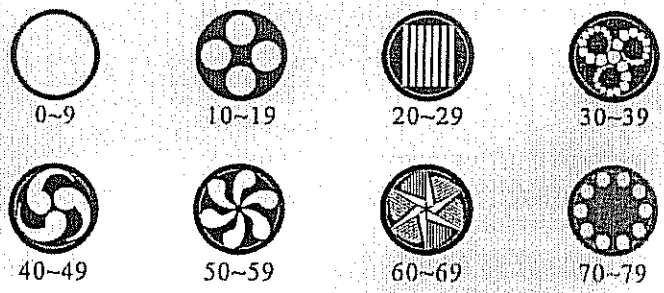
Channel	DMX-value	Feature
1 PAN	0~255	Pan540°
2 TILT	0~255	Tilt270°
3 PAN 16bit	0~255	PAN 16bit
4 TILT 16bit	0~255	TILT 16bit
5 XY Speed	0~255	XY with decreasing speed
6 Color Wheel	0~7	White
	8~15	Blue
	16~23	Yellow
	24~31	Pink
	32~39	Green
	40~47	Red
	48~55	Light Blue
	56~63	orange red
	64~66	White
	67~78	From White To Blue
	79~92	From Blue To Yellow
	93~107	From Yellow To Pink
	108~120	From Pink To Green
	121~136	From Green To Red
	137~152	From Red To Light Blue
	153~170	From Light Blue To orange red
171~212	Positive rainbow effect with increasing speed	
213~255	Negative rainbow effect with increasing speed	
7 GOBO Wheel		

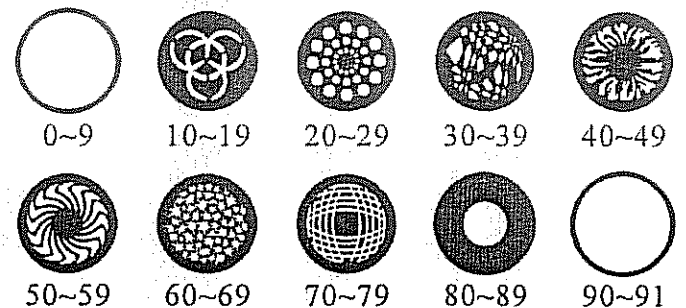







Channel	DMX-value	Feature
7 GOBO Wheel	80~99	Gobo 1 Shake with increasing speed
	100~119	Gobo 2 Shake with increasing speed
	120~139	Gobo 3 Shake with increasing speed
	140~159	Gobo 4 Shake with increasing speed
	160~179	Gobo 5 Shake with increasing speed
	180~199	Gobo 6 Shake with increasing speed
	200~219	Gobo 7 Shake with increasing speed
	220~237	Positive rainbow effect with increasing speed
	238~255	Negative rainbow effect with increasing speed
8 GOBO Rotation	0~10	Stop
	11~127	Gobo rotate index
	128~191	Positive rainbow effect with increasing speed
	192~255	Negative rainbow effect with increasing speed
9 Static GOBO Wheel		
	92~107	Static Gobo 1 Shake with increasing speed
	108~123	Static Gobo 2 Shake with increasing speed
	124~139	Static Gobo 3 Shake with increasing speed
	140~155	Static Gobo 4 Shake with increasing speed
	156~171	Static Gobo 5 Shake with increasing speed
	172~187	Static Gobo 6 Shake with increasing speed
	188~203	Static Gobo 7 Shake with increasing speed
	204~219	Static Gobo 8 Shake with increasing speed
	220~237	Positive rainbow effect with increasing speed
	238~255	Negative rainbow effect with increasing speed











Channel	DMX-value	Feature
10 Shutter	0~7	Close
	8~22	Open
	23~85	Strobe effect with increasing speed
	86~100	Open
	101~165	Pulse strobe
	166~180	Open
	181~245	Random Shutter
	246~255	Open
11 Dimmer	0~255	0~100% mechanic dimmer
12 Focus	0~255	Motorized focus, zoom out to zoom in
13 Iris	0~63	Iris (big to small)
	64~127	Auto zoom with increasing speed
	128~191	Zoom in slowly and Zoom out fast
	192~255	Zoom in fast and Zoom out slowly
14 Prism	0~7	White
	8~15	Stop, static prism effect
	16~127	Rotation prism effect Positive rainbow
	128~239	Rotation prism effect Negative rainbow
	240~255	Stop, static prism effect
15 Channel function	0~9	Reserved
	10~14	Blackout while pan/tilt moving
	15~19	Blackout while color wheel moving
	20~24	Disabled blackout while pan/tilt/color wheel moving
	25~29	Blackout while gobo wheel moving
	30~34	Disabled blackout while pan/tilt/gobo wheel moving
	35~39	Disabled blackout while color wheel/gobo wheel moving
	40~44	Disabled blackout while pan/tilt/color wheel/gobo wheel moving
	45~49	Reset pan
	50~54	Reset tilt
	55~59	Color Wheel 1 disk reset
	60~64	Iris disk reset
	65~69	Gobo disk reset
	70~74	Reset Gobo rotation
	75~79	Reset Gobo 2
	80~84	Reset Focus
85~89	Reset Prism	

Channel	DMX-value	Feature
15 Channel function	90~99	All channel reset
	100~129	Reserved
	130~192	Run random programme
	193~255	Sound control
16 Effect	0~9	Reserved
	10~19	Effect 1
	20~29	Effect 2
	30~39	Effect 3
	40~49	Effect 4
	50~59	Effect 5
	60~69	Effect 6
	70~79	Effect 7
	80~89	Effect 8
	90~99	Effect 9
	100~109	Effect 10
	110~119	Effect 11
	120~129	Effect 12
	130~139	Effect 13
	140~149	Effect 14
	150~159	Effect 15
	160~169	Effect 16
	170~179	Effect 17
	180~189	Effect 18
	190~199	Effect 19
	200~209	Effect 20
	210~219	Effect 21
	220~229	Effect 22
	230~239	Effect 23
	240~249	Effect 24
250~255	Effect 25	

11 Control Channel

Accept DMX512 control channel, detail as follow:

Channel	DMX-value	Feature
1 PAN	0~255	Pan540°
2 TILT	0~255	Tilt270°
3 Color Wheel	0~7	White
	8~15	Blue
	16~23	Yellow
	24~31	Pink
	32~39	Green
	40~47	Red
	48~55	Light Blue
	56~63	orange red
	64~66	White
	67~78	From White To Blue
	79~92	From Blue To Yellow
	93~107	From Yellow To Pink
	108~120	From Pink To Green
	121~136	From Green To Red
	137~152	From Red To Light Blue
	153~170	From Light Blue To orange red
	171~212	Positive rainbow effect with increasing speed
213~255	Negative rainbow effect with increasing speed	
4 GOBO Wheel	0~9	
	10~19	
	20~29	
	30~39	
	40~49	
	50~59	
	60~69	
	70~79	
	80~99	Gobo 1 Shake with increasing speed
	100~119	Gobo 2 Shake with increasing speed
120~139	Gobo 3 Shake with increasing speed	

Channel	DMX-value	Feature
4 GOBO Wheel	140~159	Gobo 4 Shake with increasing speed
	160~179	Gobo 5 Shake with increasing speed
	180~199	Gobo 6 Shake with increasing speed
	200~219	Gobo 7 Shake with increasing speed
	220~237	Positive rainbow effect with increasing speed
	238~255	Negative rainbow effect with increasing speed
5 GOBO Rotation	0~10	Stop
	11~127	Gobo rotate index
	128~191	Positive rainbow effect with increasing speed
	192~255	Negative rainbow effect with increasing speed
6 Static GOBO Wheel	0~9	
	10~19	
	20~29	
	30~39	
	40~49	
	50~59	
	60~69	
	70~79	
	80~89	
	90~91	
	92~107	Static Gobo 1 Shake with increasing speed
	108~123	Static Gobo 2 Shake with increasing speed
	124~139	Static Gobo 3 Shake with increasing speed
	140~155	Static Gobo 4 Shake with increasing speed
	156~171	Static Gobo 5 Shake with increasing speed
	172~187	Static Gobo 6 Shake with increasing speed
	188~203	Static Gobo 7 Shake with increasing speed
	204~219	Static Gobo 8 Shake with increasing speed
	220~237	Positive rainbow effect with increasing speed
	238~255	Negative rainbow effect with increasing speed
7 Shutter	0~7	Close
	8~22	Open
	23~85	Strobe effect with increasing speed
	86~100	Open
	101~165	Pulse strobe
	166~180	Open

Channel	DMX-value	Feature
7 Shutter	181~245	Random Shutter
	246~255	Open
8 Dimmer	0~255	0~100% mechanic dimmer
9 Focus	0~255	Motorized focus, zoom out to zoom in
10 Iris	0~63	Iris (big to small)
	64~127	Auto zoom with increasing speed
	128~191	Zoom in slowly and Zoom out fast
	192~255	Zoom in fast and Zoom out slowly
11 Prism	0~7	White
	8~15	Stop, static prism effect
	16~127	Rotation prism effect Positive rainbow
	128~239	Rotation prism effect Negative rainbow
	240~255	Stop, static prism effect

That Control Display

1. Top menu, present the current operation:

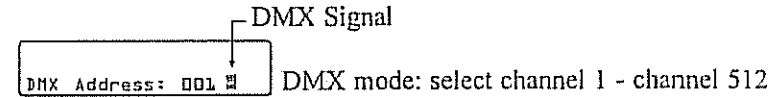

2. Press the <MODE/ESC> button repeatedly until you reach the desired menu function. Press the <ENTER> button to select the menu function currently displayed, or to enable menu option. To return to the previous option or menu without changing the value. Press the <MODE/ESC> button.

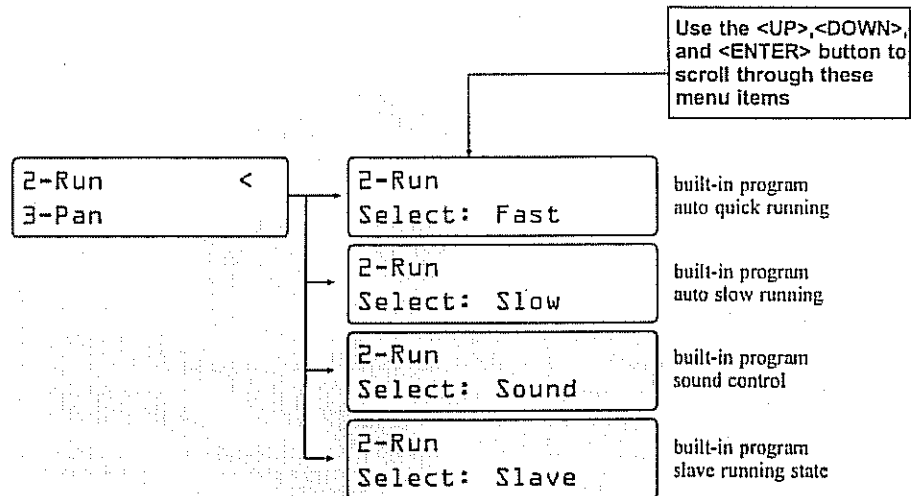
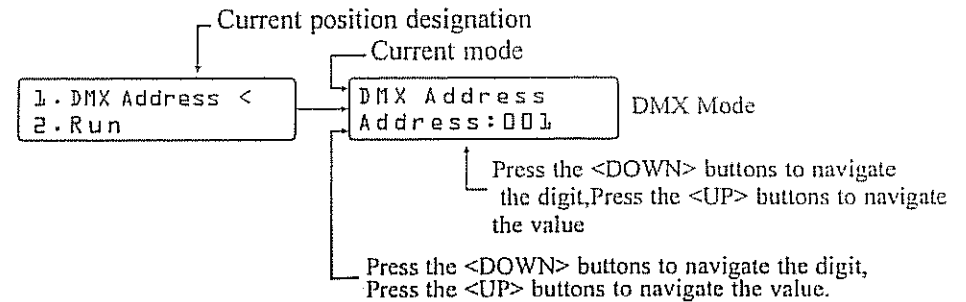

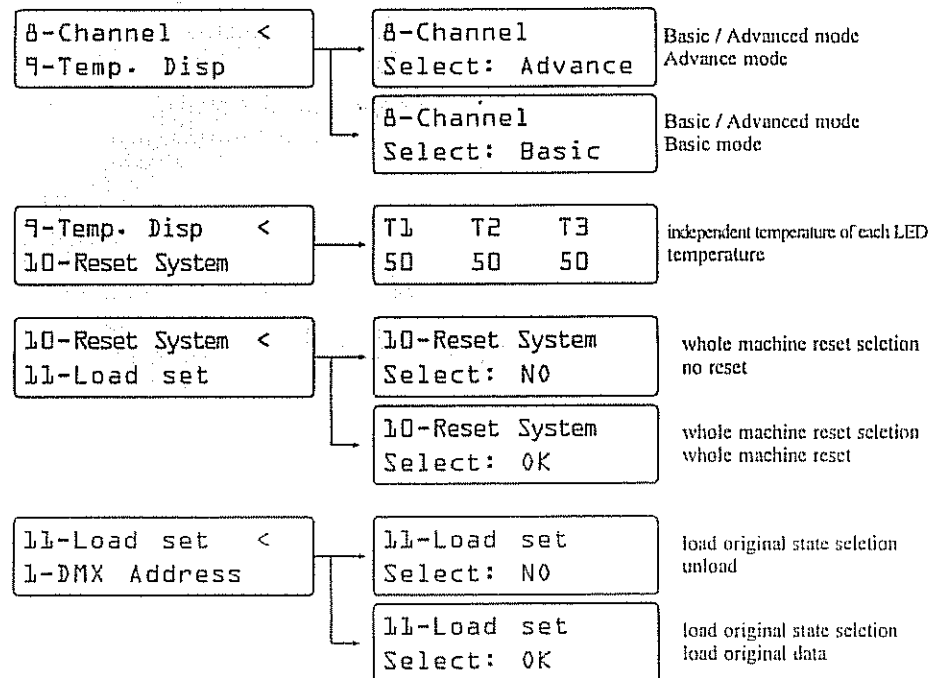
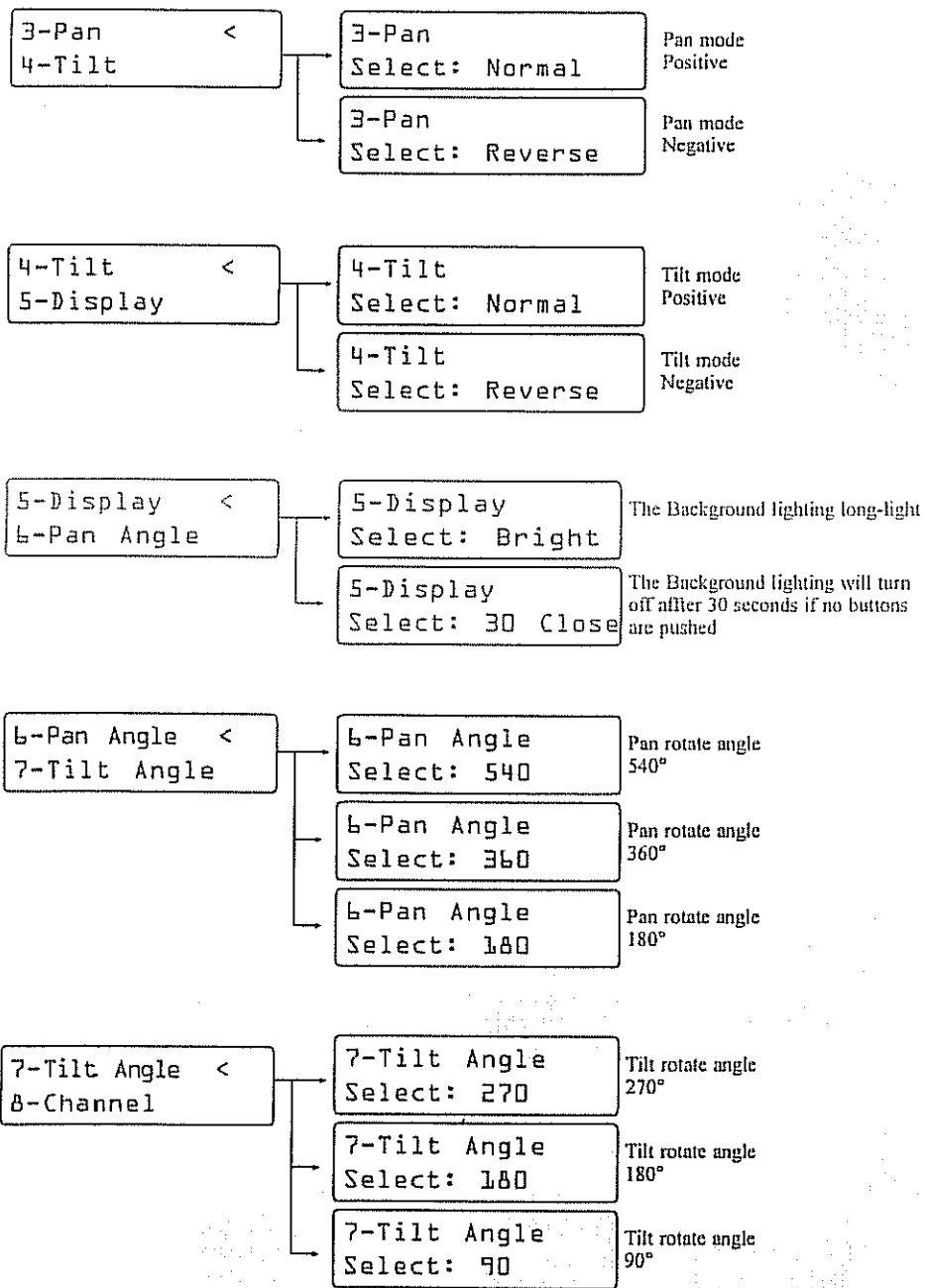

3. Service Functions. Press <MODE/ESC> at least 10 second, goes into motor start bit adjustment.

Init Motor Set
Password:0000

Press the <DOWN> buttons to navigate the digit,
Press the <UP> buttons to navigate the value

1. moto vernier regulation manual. Manufacturing code:2323. enter code and press "enter" enter the follow operation interface:

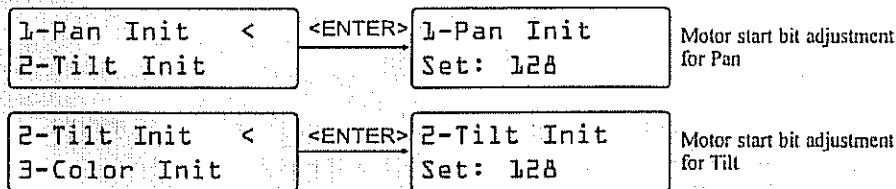

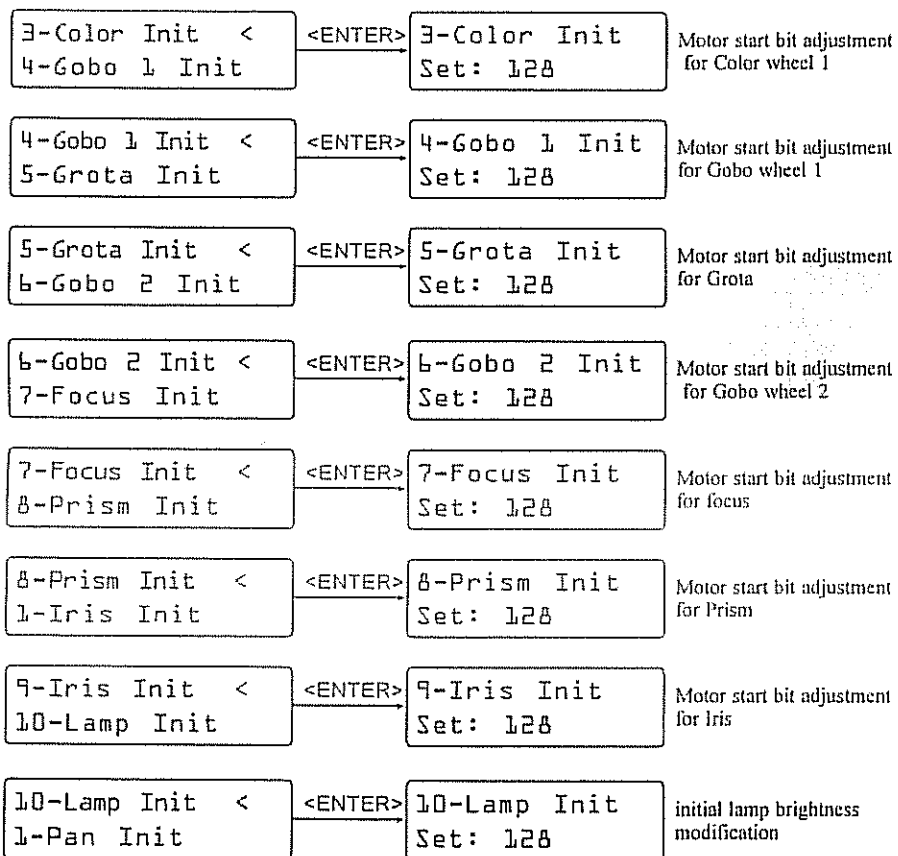

2. Password is 2322, enter the password and press <ENTER>, goes into the item:

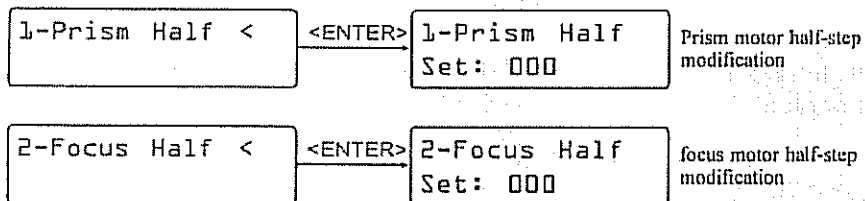

After entering into the interface above, pressing the <MODE/ESC> button can be back to the present running state or if no operating within 60s, it will exit automatically.

Fault conditions

Lamp Hot: When the LED reach 90°C, it is protected by the system and turn off automatically, and display will show "Lamp Hot".

Open: Under the condition that the temperature resistance of the LED is not connected or already damaged, the display will be "open".

Short: Under the condition that the temperature resistance of the LED is short circuited, the display will be "Short".