

User manual

eco Stage
PRO

AT-PL710-BAT-IP

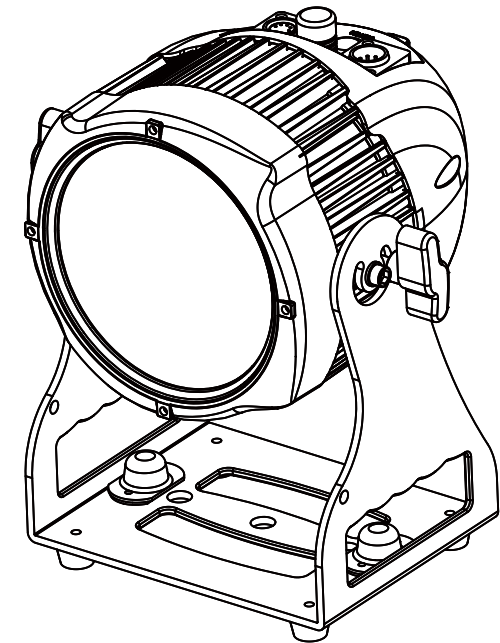

Please read carefully before use

Please Note: Specifications and improvements in the design of this unit and this manual are subject to change without any prior written notice.

Introduction

Packaging: Thanks for your purchasing the AT-PL710-BAT-IP. All the lights have been checked and are in excellent operating condition. Please check the shipping carton first, because there may be damage occurred during the shipment. Then check the lights carefully and be sure that the lights is intact and works normally. In the event damage has been found, spare parts are missing or the lights works abnormally, please contact us for further instructions. And please don't return the lights to the dealer before contacting us.

Introduction: The AT-PL710-BAT-IP has three operating modes: DMX mode, Auto mode and Master/Slave mode. And the lights has five DMX modes, including channel 2, channel 3, channel 5, channel 8 and channel 11. In addition, you can connect several pieces of lights in DMX mode and set one in Auto mode, and the others in Master/Slave mode. And then all the lights in Master/Slave mode will run following the one in Auto mode. Using fog or special effect smoke, you can see better showing effect.

SAFETY AND HANDLING

Before you operate this unit read the manual carefully. Always make sure to include the manual if you pass/rent/sell the unit to another user. Keep in mind that this manual cannot address all possible dangers and environments. Please use your own caution when operating. This product is for professional use only. It is not for household use.



- Do not operate the unit in areas of high temperature conditions. It will cause abnormal function or damage the product.
- Always use a suitable safety wire when mounting the light overhead.
- Connect the safety wire only to the intended safety mount.
- Always follow local safety requirements.



- Only qualified personnel may repair this product.
- Do not open the product housing.
- Do not apply power if the light is damaged.



- Do not directly look into the light.
- It can cause harm to your eyes.
- Do not look at the LEDs with a magnifying glass or any other optical instrument that may concentrate the light output.



- The exterior surfaces of the light can become hot, up to 70°C during normal operation.
- Ensure that accidental physical contact with the device is impossible.
- Install only in ventilated locations.
- Do not cover the light.



LI-ION Battery: A rechargeable lithium ion battery is built into this unit.

- Only authorized personal may service the battery.
- Do not place in fire or heat.
- Do not use or charge the light if it is damaged.
- Avoid bumping or plunging, it may cause fire or explosion.
- Never store the battery when fully drained.
- Always recharge immediately when empty.
- Make sure to fully charge all units before storing them.
- Partially charged batteries will lose capacity.
- The battery may only be replaced with an original spare part.



- Always charge with the flight case open.
- It is recommended to charge at a temperature between 15°C and 35°C



- The light contains a lithium ion battery.
- Don't throw the unit into the garbage at the end of its lifetime.
- Make sure to dispose is according to your local ordinances and/or regulations, to avoid polluting the environment!
- The packaging is recyclable and can be disposed.

Troubleshooting

The fixture does not turn on.

The battery may be empty. Connect it to the power cable and try again.

The fixture turns on and the display is on, but the LEDs do not emit light.

The fixture could be set to BLACKOUT mode, set to is DMX Hold and doesn't receive a valid signal. It is good practice to do a Factory Reset.

The fixture is not working correctly - it does not display the color or effect chosen.

The fixture may still be operating under a previous setting. It is good practice to do a Factory Reset.

After completing a RESET SETTINGS, the fixture still cannot be controlled.

Please turn off the light and turn on again,if cannot be controlled, too, please consult authorized personal.

The fixture does not run long enough on battery.

The required RUNTIME can be set. It defaults to several hours. To achieve a greater battery runtime, set the RUNTIME to the required value.

Alternatively, program the fixture to only display colors that use less power, such as Red, Green, Blue and White.

If the runtime is still too short, consider that it is reduced slightly if the battery is very cold.

The power cable is connected but the fixture is not charging.

The battery may be fully charged. Please read our user manual for more details. The fixture will only commence charging when its battery has a temperature of 45° or less. Turn the fixture off and let it cool down; once cold enough, it will start charging. If it still not charging, please consult authorized personal.

UPLOAD

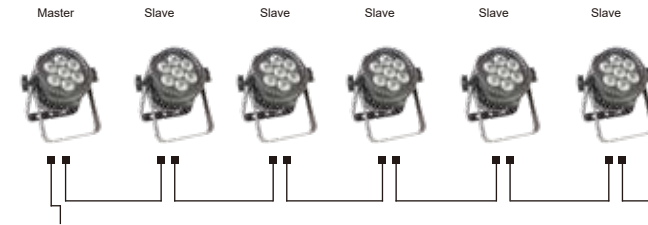

First,set one light, which involves the program you have edited in EDIT menu and want to upload, in Master mode,and others in Slave mode.

Then,connect all the lights with DMX cables.Finally,select the UPLOAD menu of the Master light and press ENTER.All the programs edited in the Master light will be uploaded to the Slave lights.

Channel 11 (Id address set)

0--9	all Ids	170--179	Id17	223	Id34	240	Id51
10--19	Id1	180--189	Id18	224	Id35	241	Id52
20--29	Id2	190--199	Id19	225	Id36	242	Id53
30--39	Id3	200--209	Id20	226	Id37	243	Id54
40--49	Id4	210	Id21	227	Id38	244	Id55
50--59	Id5	211	Id22	228	Id39	245	Id56
60--69	Id6	212	Id23	229	Id40	246	Id57
70--79	Id7	213	Id24	230	Id41	247	Id58
80--89	Id8	214	Id25	231	Id42	248	Id59
90--99	Id9	215	Id26	232	Id43	249	Id60
100--109	Id10	216	Id27	233	Id44	250	Id61
110--119	Id11	217	Id28	234	Id45	251	Id62
120--129	Id12	218	Id29	235	Id46	252	Id63
130--139	Id13	219	Id30	236	Id47	253	Id64
140--149	Id14	220	Id31	237	Id48	254	Id65
150--159	Id15	221	Id32	238	Id49	255	Id66
160--169	Id16	222	Id33	239	Id50		

Mechanical Specification

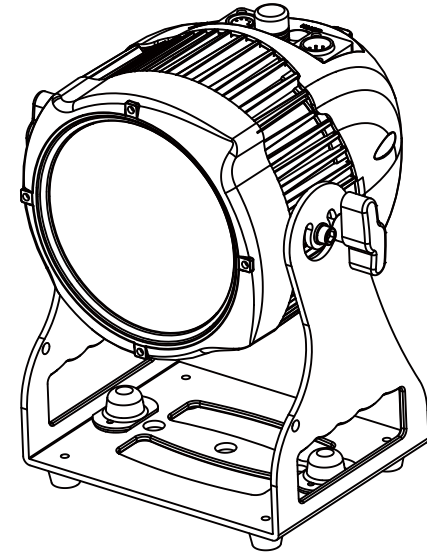

DMX-512 addressing with ID address

1. Follow instructions 1 for DMX 512 addressing.
2. Activate ID addressing in each fixture by setting panel function "ID ON/OFF" to ON. "Settings" to "ID ON/OFF" to "ON" For every DMX 512 starting address the user can set 66 separate ID addresses. Set ID addresses in each fixture by setting panel function " ID address" to incremental values.(i.e. 1, 12, 24, 36 etc...) "Settings" to "address" to "01~66".

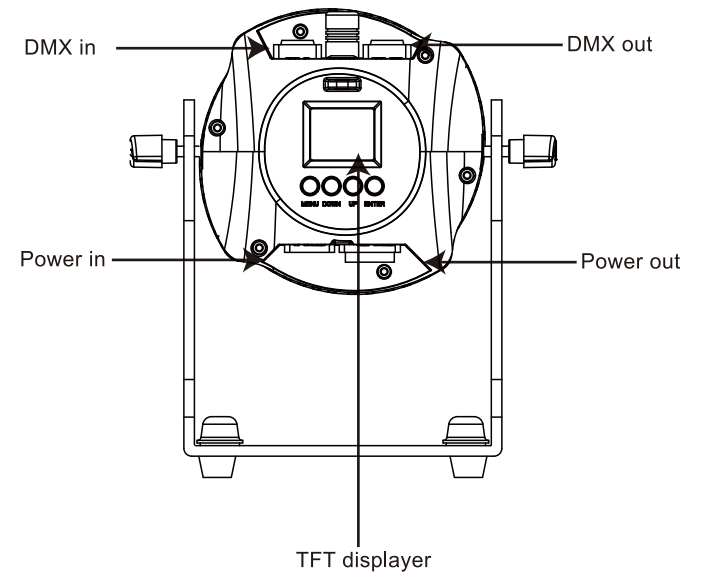
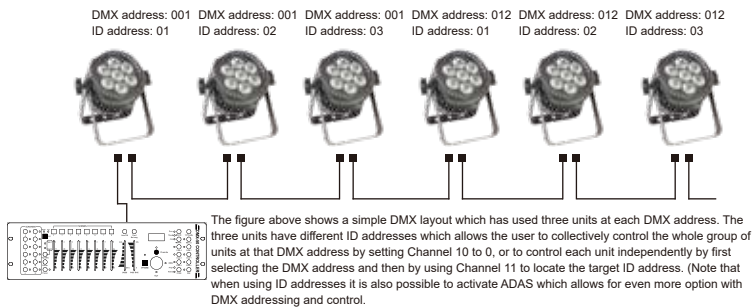

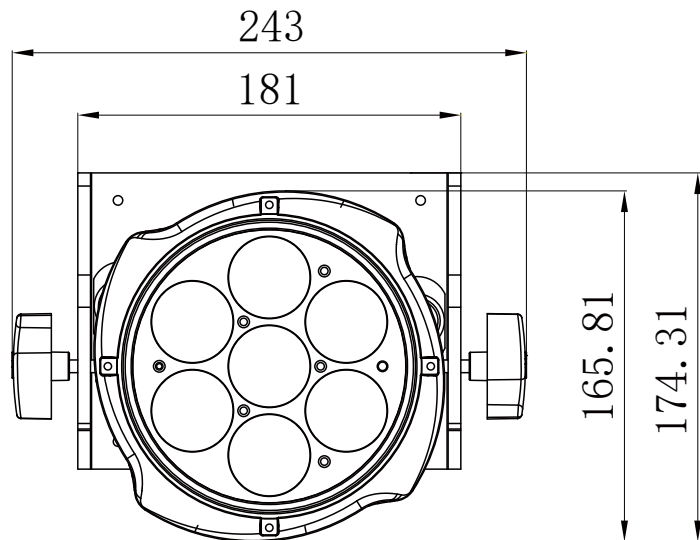
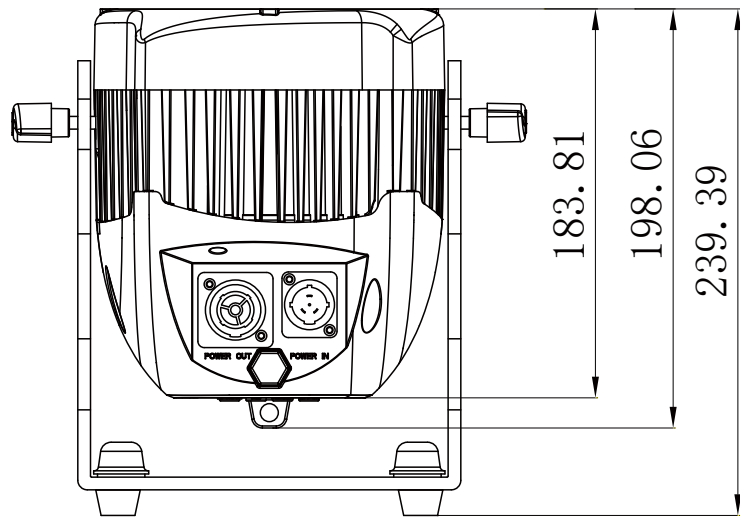

channel	value	function
7	220 - 222	Flesh pink
	223 - 255	Skelton exotic sangria
8	0	No functions
	1 - 23	2500 K
	24 - 47	3000 K
	48 - 71	3500 K
	72 - 95	4000 K
	96 - 119	4500 K
	120 - 143	5000 K
	144 - 167	6000 K
	168 - 191	7000 K
	192 - 215	8000 K
	216 - 225	9000 K
	226 - 255	10000 K
9	0 - 7	No function
	8 - 23	AUTO 1
	24 - 39	AUTO 2
	40 - 55	AUTO 3
	56 - 71	AUTO 4
	72 - 87	AUTO 5
	88 - 103	AUTO 6
	104 - 119	AUTO 7
	120 - 129	AUTO 8
	130 - 151	AUTO 9
	152 - 168	AUTO 10
	169 - 183	AUTO 11
	184 - 199	AUTO 12
200 - 255	AUTO 13	
10	0 - 255	Auto modes speed
11	0 - 255	Id address set

DMX 11 channel

channel	value	function
7	40 - 43	Cyan
	44 - 47	Magenta
	48 - 51	White
	52 - 55	Yellow
	56 - 59	Pink
	60 - 63	Violet
	64 - 67	Aquamarine
	68 - 71	Pale blue
	72 - 75	Full white
	76 - 79	Cool white
	80 - 83	Day light
	84 - 87	Warm white
	88 - 91	Tungsten
	92 - 95	Medium amber
	96 - 99	Straw
	100 - 103	Spring yellow
	104 - 107	Light rose
	108 - 111	Dark pink
	112 - 115	Magenta 2
	116 - 123	Med blue green
	124 - 127	Blue 2
	128 - 131	Bright pink
	132 - 135	Medium blue
	136 - 139	Violet
	140 - 143	Medium yellow
	144 - 147	Apricot
	148 - 151	Pale yellow
	152 - 155	Pale Lavender
	156 - 159	Pale yellow 2
	160 - 163	Evening blue
	164 - 167	Surprise pink
	168 - 171	Scarlet
	172 - 175	Surprise peach
	176 - 179	Light peach
	180 - 183	Warm white 2
	184 - 187	Mauve
	188 - 191	Bright blue
	192 - 195	Alice blue
	196 - 199	Rose indigo
	200 - 203	Urban blue
	204 - 207	Cool blue
	208 - 211	Light salmon
	212 - 215	Mayan sun
	216 - 219	Cherry rose

Mounting

When installing the unit, the trussing or area of installation must be able to hold 10 times the weight without any deformation. When installing the unit must be secured with a secondary safety attachment, e.g. and appropriate safety cable. Never stand directly below the unit when mounting, removing, or servicing the unit.

Overhead mounting requires extensive experience, including calculating working load limits, installation material being used, and periodic safety inspection of all installation material and unit. If you lack these qualifications, do not attempt the installation yourself.

The installation should be checked by a skilled person once a year.

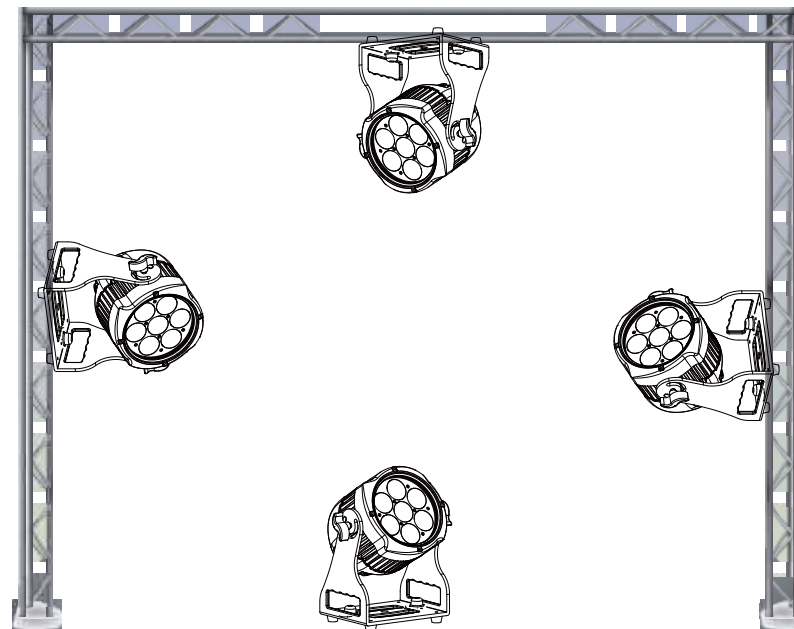

The AT-PL710-BAT-IP is fully operational in three different mounting positions, hanging upside-down from a ceiling, set on a flat level surface or mount the unit on its side. Be sure this fixture is kept at least 0.5m away from any flammable materials (decoration etc.). And you'd better use and install the supplied safety cable as a safety measure to prevent accidental damage and/or injury in the event the clamp fails (see next page).

CABLE CONNECTORS

Cabling must have a male XLR connector on one end and a female XLR connector on the other end.

DMX connector configuration

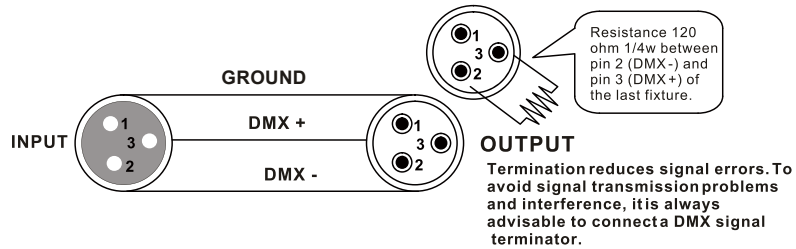

caution: Do not allow contact between the ground and the fixture's chassis ground. Grounding the ground can cause a ground loop, and your fixture may perform erratically. Test cables with an ohm meter to verify positive pole and to make sure the pins are not grounded or shorted to the shield or each other.

3-PIN TO 5-PIN CONVERSION CHART

Note! If you use a controller with a 5 pin DMX output connector, you need to use a 5 pin to 3 pin adapter. The chart below details a proper cable conversion:

3-PIN TO 5-PIN CONVERSION CHART

Conductor	3 Pin Female (output)	5 Pin Male (Input)
Ground/Shield	Pin 1	Pin 1
Data (-) signal	Pin 2	Pin 2
Data (+) signal	Pin 3	Pin 3
Do not use		Do not use
Do not use		Do not use

DMX 8 channel

channel	value	function
1	0 - 255	Master Dimmer
2	0 - 9	No functions (LED ON)
	10 - 189	Strobe from slow to fast
	190 - 199	No functions (LED ON)
	200 - 249	Random strobe from slow to fast
	250 - 255	No functions (LED ON)
3	0 - 255	Red
4	0 - 255	Green
5	0 - 255	Blue
6	0 - 255	White
7	0 - 7	No function
	8 - 23	AUTO 1
	24 - 39	AUTO 2
	40 - 55	AUTO 3
	56 - 71	AUTO 4
	72 - 87	AUTO 5
	88 - 103	AUTO 6
	104 - 119	AUTO 7
	120 - 129	AUTO 8
	130 - 151	AUTO 9
	152 - 168	AUTO 10
	169 - 183	AUTO 11
	184 - 199	AUTO 12
200 - 255	AUTO 13	
8	0 - 255	Auto modes speed

DMX 11 channel

channel	value	function
1	0 - 255	Master Dimmer
2	0 - 9	No functions (LED ON)
	10 - 189	Strobe from slow to fast
	190 - 199	No functions (LED ON)
	200 - 249	Random strobe from slow to fast
	250 - 255	No functions (LED ON)
3	0 - 255	Red
4	0 - 255	Green
5	0 - 255	Blue
6	0 - 255	White
7	0 - 23	No function
	24 - 27	Red
	28 - 31	Green
	32 - 35	Blue
	36 - 39	Orange

channel	value	function
	192 - 195	Alice blue
	196 - 199	Rose indigo
	200 - 203	Urban blue
	204 - 207	Cool blue
	208 - 211	Light salmon
	212 - 215	Mayan sun
	216 - 219	Cherry rose
	220 - 222	Flesh pink
	223 - 255	Skelton exotic sangria
2	0	No functions
	1 - 23	2500 K
	24 - 47	3000 K
	48 - 71	3500 K
	72 - 95	4000 K
	96 - 119	4500 K
	120 - 143	5000 K
	144 - 167	6000 K
	168 - 191	7000 K
	192 - 215	8000 K
	216 - 225	9000 K
	226 - 255	10000 K

DMX 3 channel

channel	value	function
1	0 - 255	Hue
2	0 - 255	Saturation
3	0 - 255	Brightness

DMX 5 channel

channel	value	function
1	0 - 255	Master dimmer
2	0 - 255	Red
3	0 - 255	Green
4	0 - 255	Blue
5	0 - 255	White

Package Contents

- 1 x power plug
- 1 x user manual
- 1 x frost filter

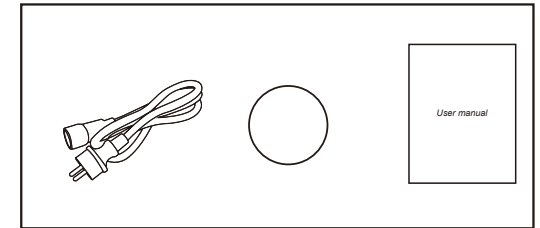

Filters

The effect of the filters can be seen below:

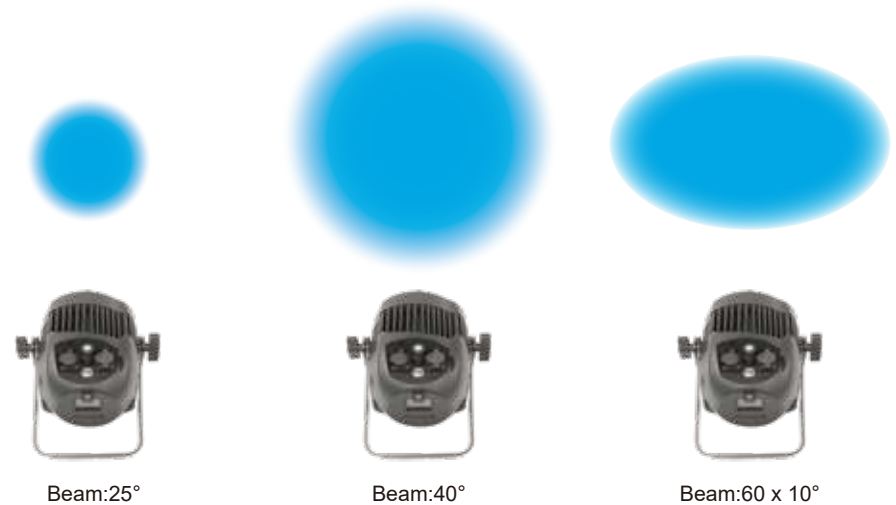

NOTE: Each filter has its name inscribed on the edge

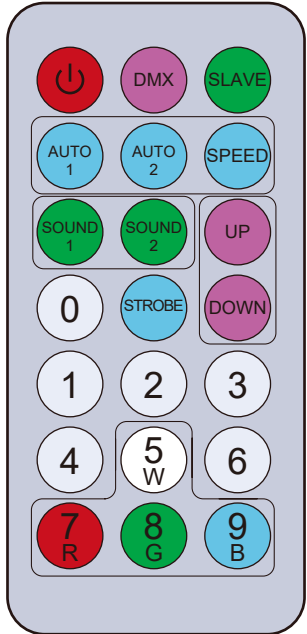

IR Controller



 Power on/off button



 DMX button, to control DMX address when press this button. It is channel mode when double click.

 Master-slave mode button.

  Automatic mode button

 Speed adjustable button

  Without function

  Up and down button, you can choose the program that you need or numerical.

 Strobe button



You can use these number button to adjust numerical in any program mode.

    Color choosing button.

DMX control mode

DMX 2 channel

channel	value	function
1	0 - 23	No function
	24 - 27	Red
	28 - 31	Green
	32 - 35	Blue
	36 - 39	Orange
	40 - 43	Cyan
	44 - 47	Magenta
	48 - 51	White
	52 - 55	Yellow
	56 - 59	Pink
	60 - 63	Violet
	64 - 67	Aquamarine
	68 - 71	Pale blue
	72 - 75	Full white
	76 - 79	Cool white
	80 - 83	Day light
	84 - 87	Warm white
	88 - 91	Tungsten
92 - 95	Medium amber	
96 - 99	Straw	
100 - 103	Spring yellow	
104 - 107	Light rose	
108 - 111	Dark pink	
112 - 115	Magenta 2	
116 - 123	Med blue green	
124 - 127	Blue 2	
128 - 131	Bright pink	
132 - 135	Medium blue	
136 - 139	Violet	
140 - 143	Medium yellow	
144 - 147	Apricot	
148 - 151	Pale yellow	
152 - 155	Pale Lavender	
156 - 159	Pale yellow 2	
160 - 163	Evening blue	
164 - 167	Surprise pink	
168 - 171	Scarlet	
172 - 175	Surprise peach	
176 - 179	Light peach	
180 - 183	Warm white 2	
184 - 187	Mauve	
188 - 191	Bright blue	

AUTO-In this menu, you can select your desire AUTO mode and adjust the running speed.

1. Press "ENTER" button and then UP or DOWN button until "AUTO" is showed.
2. Press "ENTER" button, and "SPEED" or "AUTO MODE" will be showed. Then press ENTER, and you can see two items as below:
 - 1) SPEED - You can select your desired speed in this menu.
 - 2) AUTO MODE - You can select your desired auto mode in this menu.

CUSTOMER-In this menu, you can select the AUTO program edited in the "EDIT" menu.

1. Press "ENTER" button and then UP or DOWN button until "CUSTOMER" is showed.
2. Press "ENTER" button, and there are 11 pre-programmed mode edited in the "EDIT" menu.

CAL WHITE-In this menu, you can adjust the value of 11 different white color.

1. Press "ENTER" button and then UP or DOWN button until "CAL WHITE" is showed.
2. Press "ENTER" button, and there are 11 pre-programmed White colors that can be edited by adjusting the value of "Red", "Green", "Blue" and "White"

STAT COLOR-In this menu, you can adjust the value of static color and strobe speed as you like.

1. Press "ENTER" button and then UP or DOWN button until "STAT COLOR" is showed.
2. Press "ENTER" button, and there are six options. Then press ENTER to select the option and press UP or DOWN button to select the value you desire as below:
 - 1) STAT RED - You can adjust the red brightness in this menu.
 - 2) STAT GREEN - You can adjust the green brightness in this menu.
 - 3) STAT BLUE - You can adjust the blue brightness in this menu.
 - 4) STAT WHITE - You can adjust the white brightness in this menu.
 - 5) SELET COLOR -You can select 52 static color in this menu.
 - 6) STAT STROB - You can adjust the strobe speed in this menu.

EDIT-In this menu, you can edit your desired AUTO program.

1. Press "ENTER" button and then UP or DOWN button until "EDIT" is showed.
2. Press "ENTER" button, and open the "EDIT" mode to edit the custom programs from "PR.01" to "PR.11". And there are 32 scenes that can be edited in each custom program.
3. You can edit a scene by adjusting the value of "RED (0~255)", "GREEN (0~255)", "BLUE (0~255)", "WHITE (0~255)", "FADE (0~31)", "FLASH(0~50)", "STROBE (0~31)" & "TIME (0~100)" as you like. Then the data will be saved, when you press the ENTER button for 5 seconds.

UPLOAD-In this menu, you can connect several pieces of lights with MAX cables and set one light as the MASTER and others in SLAVE mode. Then upload the custom program in the MASTER light to the lights in SLAVE mode.

1. Press "ENTER" button and then UP or DOWN button until "UPLOAD" is showed.
2. Press "ENTER" button to upload the custom programs from the MASTER light to the SLAVE ones.

RESET-In this menu, you can reset all the value of the system.

1. Press "ENTER" button and then UP or DOWN button until "RESET" is showed.
2. Press the ENTER button to reset all the value of the system.

Displayer Introduction

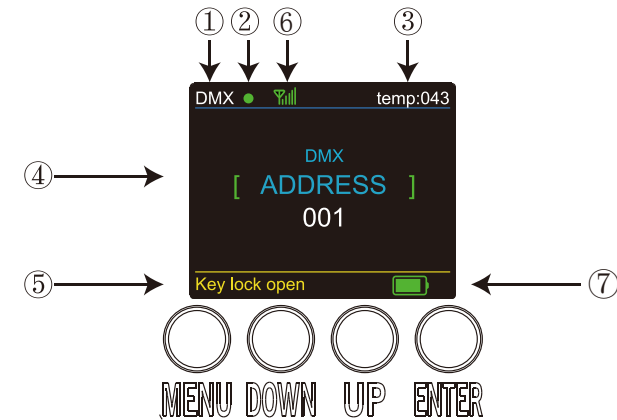

1. When you enter DMX Mode, it will be showed DMX, when you enter SLAVE Mode, it will be showed SLAVE.
2. This shows the condition of signal transmission. Green is connected. Red is disconnected.
3. This shows the temperature of the lights.
4. This shows the menus you can select.
5. This shows the condition of key lock. "Key lock open" means it is open and "Key lock off" means it is close.
6. This shows the condition of wireless signal. Green is connected. Red is disconnected.
7. This shows the battery's electric quantity.

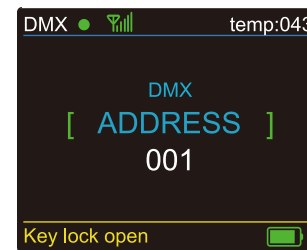

While DMX and Wireless signal are green, it means DMX Mode and Wireless are connected.

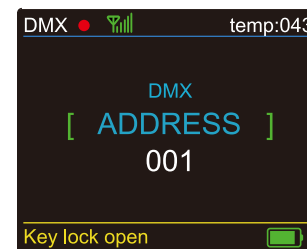

While DMX shows red but Wireless signal shows green, it means DMX Mode is disconnected and Wireless is connected.

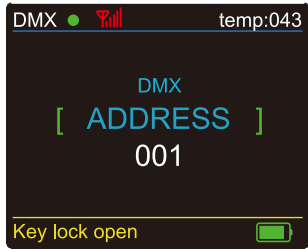

While DMX shows green but Wireless signal shows red, it means DMX Mode is connected and Wireless is disconnected.

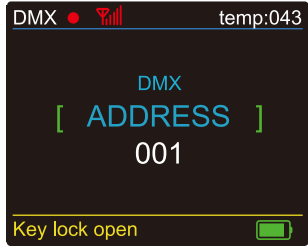

While DMX and Wireless are shown red, it means DMX Mode and Wireless are disconnected.

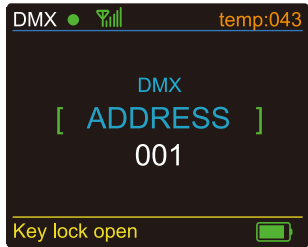

While the letters and number show change from white to yellow, it means the temperature is beyond the maximum temperature of default settings.

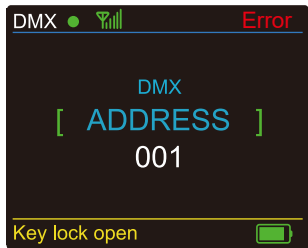

While the letters and number show Error, it means there are some temperature problems.

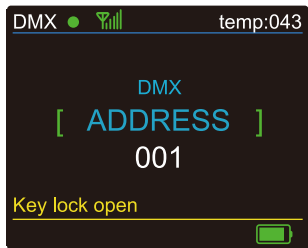

While the battery is charging, it will show running from empty to full. When you stop charging, it will show how much the electric quantity.

DMX-In this menu, you can connect several pieces of lights with DMX cable and control them with control console.

1. Press "ENTER" button and then UP or DOWN button until "DMX" is shown.
2. Press "ENTER" button, and "CHANNEL" or "ADDRESS" will be shown. Then press ENTER.
 - 1) "Channel [xx]" will be shown, "X" represents the shown DMX channel mode. You can press the UP or DOWN button to select your desired Channel mode.
 - 2) "xxx" will be shown, "x" represents the shown address. You can press the UP or DOWN button to select your desired address.

RUN MODE-In this menu, you can select DMX mode or SLAVE mode. In SLAVE mode, you can select one light as the MASTER light and other lights in SLAVE mode will run following the MASTER light.

1. Press "ENTER" button and then UP or DOWN button until "RUN MODE" is shown.
2. Press "ENTER" button, and "DMX" or "SLAVE" will be shown, then press ENTER to select your desired mode.

SET UP-In this menu, you can adjust the value of the function.

1. Press "ENTER" button and then UP or DOWN button until "SET UP" is shown.
2. Press "ENTER" button, and there will be nine options. Then, press ENTER to select the option and press UP or DOWN button to select the value you desire as below.
 - 1) ID number - You can select an ID Number in this menu. Then, you can adjust the value of channel 11 to the corresponding scope and control the light individually with control console.
 - 2) Display Led - In this item, you can select "ON" or "OFF". If you select ON, the displayer will be on all the time. And if you select OFF, the displayer will extinguish about ten seconds later.
 - 3) Key locks - You can select whether the password is on or off in this menu, and the password is [DOWN] + [UP] + [DOWN] + [UP]. If you select "on", then you have to input the password before pressing the buttons. Otherwise, the light won't respond to your order.
 - 4) Max temp - You can set your desired Max working temperature about the light in this menu. When the working temperature of the light exceeds the Max temperature, the color of the letter "Temp xx" shown in the menu will change from white to yellow. Meanwhile, the light will adjust the working temperature automatically.
 - 5) Dimmer RED - You can adjust the red brightness in this menu.
 - 6) Dimmer GREEN - You can adjust the green brightness in this menu.
 - 7) Dimmer BLUE - You can adjust the blue brightness in this menu.
 - 8) Dimmer WHITE - You can adjust the white brightness in this menu.
 - 9) Dimmer ALL - You can adjust the brightness of each color in this menu.

INFORMATION-In this menu, you can learn about the information of software, hardware and the working time of the light.

1. Press "ENTER" button and then UP or DOWN button until "INFORMATION" is shown.
2. Press "ENTER" button, and "Software" "Hardware" or "Fix times" will be shown. Then press ENTER, and you can see three items as below:
 - 1) Software - This item displays the Software information.
 - 2) Hardware - This item displays the Hardware information.
 - 3) Fix times - This item displays the working hours about the light.

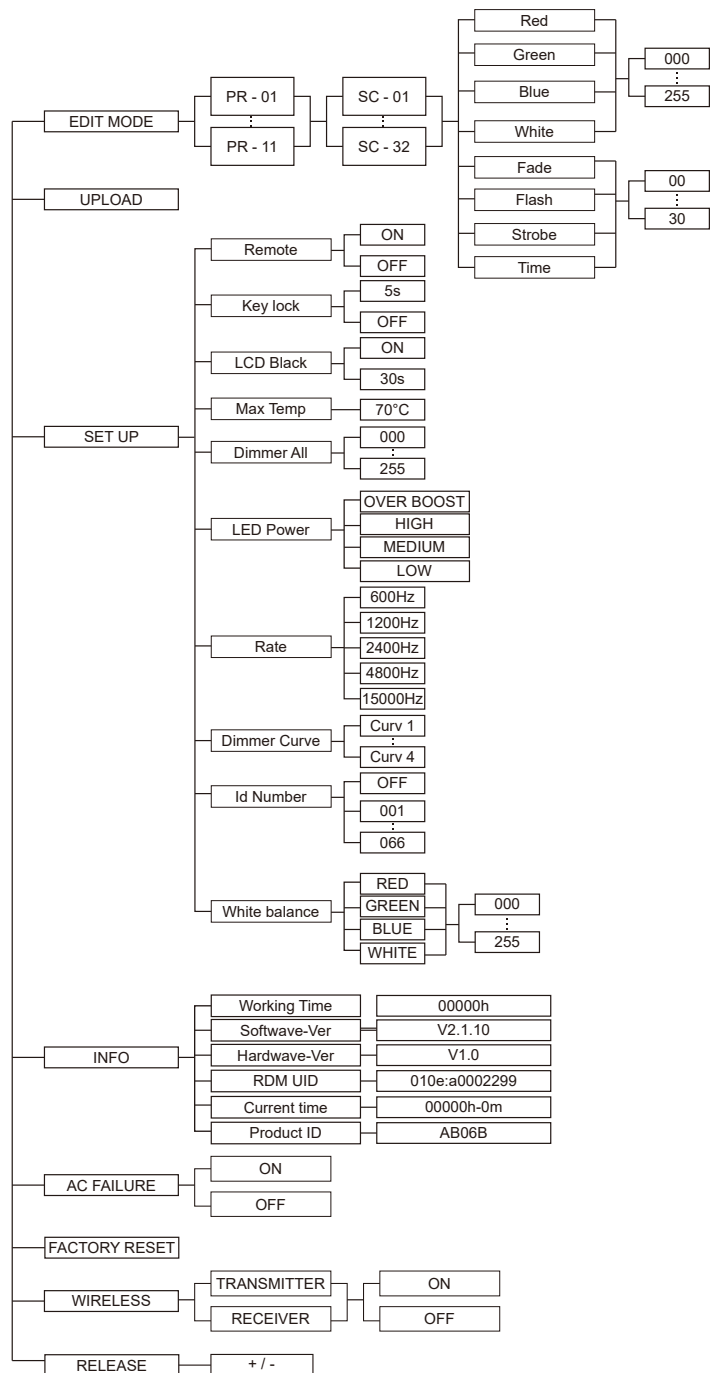

Connection

DMX connection

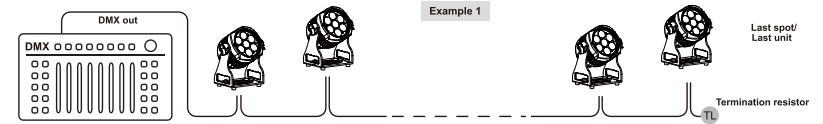

Master / Slave connection

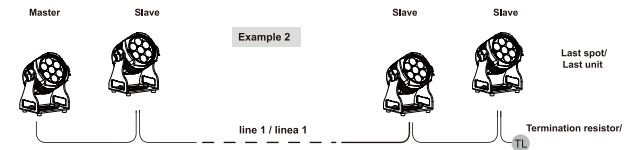

Wireless connection

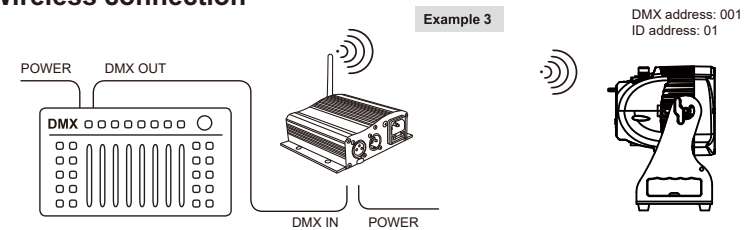

Press “ENTER” button and then “UP” or “DOWN” button until “SET UP” is showed. Press “ENTER” button and then “UP” or “DOWN” button until “Wireless rel” is displayed, press ENTER button. Then press DMX Mode is ok. Then, until Green wireless signal is displayed. Then Wireless DMX connected success.

About the condition of wireless signal, Green represents the successful setting, while red represents the signal is unsuccessful.

Release wireless DMX signal

Press “ENTER” button and then “UP” or “DOWN” button until “Wireless rel” is showed. Press “ENTER” button and then “UP” or “DOWN” button until “press +/-” is displayed, press “UP” or “DOWN” button, long press “UP” or “DOWN” button about 5-6 seconds. Until “Initialization” to “Release finish” is displayed. It means release signal successfully.

Please noted:The wireless controller hangs on will be in a good position,the antenna of the products should be face to the controller can be used within 200M.

Features

- Light Source: 7*10W, 4 in 1 RGBW LEDs
- Lens:8°
- Power consumption: 70W
- Voltage: AC 110-230V 50/ 60Hz
- Run mode: DMX 512 /Master Slave /Auto Run / Wireless DMX
- DMX channels: 2, 3, 5, 8& 11 CH
- Built-in Effect: color mixing, variable color chasing, strobing, dimmer and fading
- 4 dimmer curves
- TFT displayer with four buttons
- Battery:5 hours for full on, Color change and dimming with 20 hours, 8 hours for charging, quality lithum battery, can choose OVER BOOST, HIGH,MEDIUM or LOW for the battery using
- Material: Aluminum body
- IP65
- Temperature: -30°C~45°C
- Dimension:174×243×240mm
- N.W: 4.9 KG
- G.W: 6 KG

Programme Menu

